



GATOR[®]

PRODUCT CATALOG

MUSIC ACCESSORIES

WWW.GATORCO.COM



NEW!
VERTEX SERIES
PEDALBOARDS & BAGS
PAGE 76



CONTENTS

FURNITURE	6
GUITAR	24
KEYBOARD	104
BAND & ORCHESTRA	130
PERCUSSION	160
CABLES	186

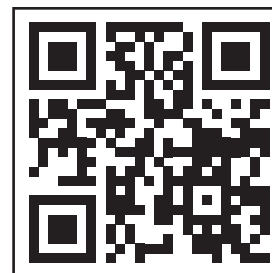

BECOME AN INSIDER

Sign up for our newsletter,
check out our other products
and follow us on social.

Follow us on social:



@gatorcases

FURNITURE

The new Gator Frameworks elite furniture series features a contemporary design with superb quality in every detail. Our goal is to deliver the very best features, style, and quality with an aesthetic to match any home or studio decor.



GUITAR STANDS.....	6	KEYBOARD TABLES.....	18
GUITAR RACKS.....	12	DESKTOP SYNTHS.....	20
AMPLIFIER STANDS.....	16		

ELITE SERIES X STAND

ELITE FURNITURE SERIES GUITAR X-STYLE STAND



FEATURED MODEL
GFW-ELITEGTRXSTD-GRY

- Elegantly Displays Instrument in Studio, Living Room, Showroom Floor, or Similar Environment
- Sturdy 18mm Plywood Construction for Safely Holding Electric & Acoustic Guitars & Basses
- Assembles & Disassembles Quickly for Easy Travel & Setup
- 0.1"/3mm-Thick EVA Foam Cradle Padding Comfortably Grips Base of Guitar
- Safe for Standard Polyurethane Finishes, Not Tested for Compatibility with Vintage/Lacquer Finishes
- Maximum Cradle Depth: 6"/152mm
- Product Dimensions: 16"/406mm (L) x 14.5"/368mm (W) x 9.5"/241mm (H), Net Weight: 2.5 lbs./1.1 kg



PADDED CRADLE



FEATURED MODEL
GFW-ELITEGTRXSTD-BRN



FEATURED MODEL
GFW-ELITEGTRXSTD-MPL



Elite Series Guitar X Stand
in Black Finish
MODEL: GFW-ELITEGTRXSTD-BLK



Elite Series Guitar X Stand
in Driftwood Grey Finish
MODEL: GFW-ELITEGTRXSTD-GRY



Elite Series Guitar X Stand
in Dark Walnut Finish
MODEL: GFW-ELITEGTRXSTD-BRN



Elite Series Guitar X Stand
in Maple Finish
MODEL: GFW-ELITEGTRXSTD-MPL

ELITE SERIES HANGING STAND

ELITE FURNITURE SERIES HANGING GUITAR STAND



Elite Series Hanging Guitar Stand in Driftwood Grey Finish
MODEL: GFW-ELITEGTRHNGSTD-GRY

- Elegantly Displays Instrument in Studio, Living Room, Showroom Floor, or Similar Environment
- Sturdy 25mm-Thick Plywood Construction with Stable 13"/330mm-Wide Base for Safely Holding Acoustic, Electric & Bass Guitars
- 2"/51mm-Wide Rubberized Yoke with Soft Plastic End Caps to Prevent Scratches to Headstock & Neck
- Can Be Placed Directly Up Against Wall without Headstock Contact
- Product Dimensions: 13.5"/343mm (L) x 13"/330mm (W) x 43"/1092mm (H), Net Weight: 6.8 lbs./3.1 kg
- Easy to Assemble



RUBBERIZED YOKE



FLAT BACK TO SIT AGAINST WALL



Elite Series Hanging Guitar Stand in Dark Walnut Finish
MODEL: GFW-ELITEGTRHNGSTD-BRN



Elite Series Hanging Guitar Stand in Maple Finish
MODEL: GFW-ELITEGTRHNGSTD-MPL



Elite Series Hanging Guitar Stand in Black Finish
MODEL: GFW-ELITEGTRHNGSTD-BLK

ELITE SERIES 2X HANGING STAND

ELITE FURNITURE SERIES DOUBLE GUITAR HANGING STAND

Elite Series Double Hanging
Guitar Stand in Driftwood Grey
MODEL: GFW-ELITEGTRHNGSTD-2X-GRY

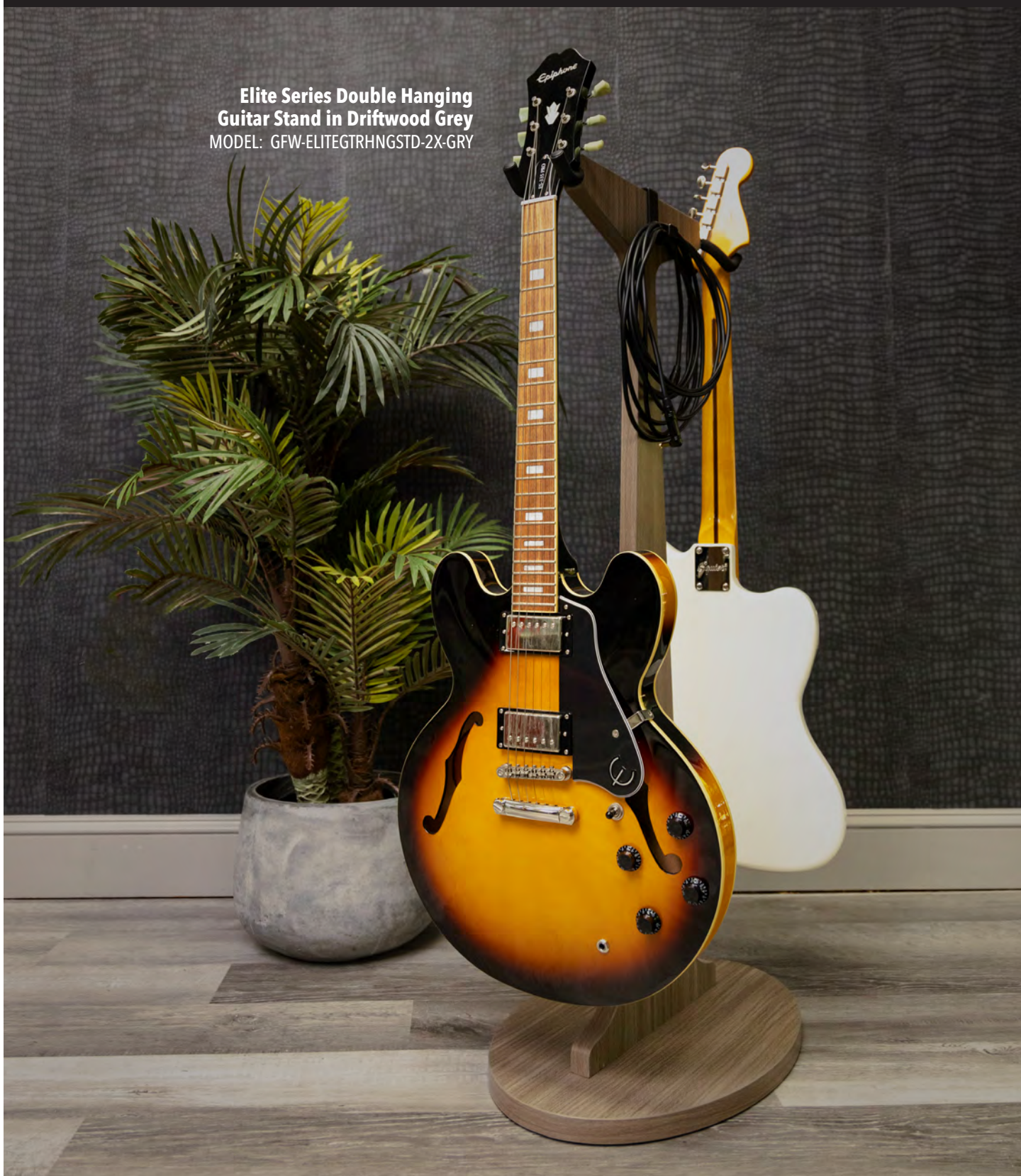

- Elegantly Displays Instrument in Studio, Living Room, Showroom Floor, or Similar Environment
- Sturdy 25mm-Thick Plywood Construction with Stable 20 x 13 (508 x 330mm) Base for Safely Holding up to Two (2) Acoustic, Electric & Bass Guitars
- 2/51mm-Wide Rubberized Yoke with Soft Plastic End Caps to Prevent Scratches to Headstock & Neck
- Optional Hook for Hanging Two (2) Instrument Cables
- Safe for Standard Polyurethane Finishes, Not Tested for Compatibility with Vintage/Lacquer Finishes
- Easy to Assemble
- Product Dimensions (Upright): 20508/mm (L) x 13/330mm (W) x 42.5/1080mm (H), Net Weight: 8.8 lbs./4 kg



STURDY BASE



RUBBERIZED YOKE



CABLE STORAGE HANGER



Elite Series Double Hanging
Guitar Stand in Dark Walnut
MODEL: GFW-ELITEGTRHNGSTD-2X-BRN



Elite Series Double Hanging
Guitar Stand in Dark Walnut
MODEL: GFW-ELITEGTRHNGSTD-2X-BLK



Elite Series Double Hanging
Guitar Stand in Dark Walnut
MODEL: GFW-ELITEGTRHNGSTD-2X-MPL

ELITE SERIES GUITAR RACK

ELITE FURNITURE SERIES THREE & FIVE SPACE GUITAR RACKS

FEATURED MODEL
GFW-ELITEGTR3RK-GRY



- Elegantly Displays Multiple Guitars or Cases in Studio, Living Room, Showroom Floor, Classroom, or Similar Environment
- 3-Space Rack Fits (3) to (4) Instruments and Cases or a Combination of Both
- 5-Space Rack Fits (5) to (6) Instruments, up to (7) Cases or a Combination of Both
- Adjustable Divider Pegs with Rubberized Protective Layering Keep Instruments & Cases Safely Stored & Separate from Each Other
- Holds Most Acoustic, Electric, & Bass Guitars, Including Instruments with Offset Bodies
- Soft Padding on Base of Cradle Prevents Guitar Bottoms from Contacting Wood
- Sturdy 1 1/2"-Thick Laminated Plywood Construction with Textured Wood Grain Surface
- Convenient Cable Storage Hanger Hooks on Both Sides
- Non-Slip Rubber Feet on Bottom Protects Floor from Scratches
- Safe for Standard Polyurethane Finishes, Not Tested for Compatibility with Vintage/Lacquer Finishes.



ADJUSTABLE DIVIDER PEGS



SOFT PADDING ON BASE



CABLE STORAGE HANGER



NON-SLIP RUBBER FEET



FEATURED MODEL
GFW-ELITEGTR5RK-BLK



FEATURED MODEL
GFW-ELITEGTR3RK-BRN

FEATURED MODEL
GFW-ELITEGTR3RK-MPL



Elite Series 3X Guitar Rack in Black Finish
MODEL: GFW-ELITEGTR3RK-BLK

Elite Series 3X Guitar Rack in Dark Walnut Finish
MODEL: GFW-ELITEGTR3RK-BRN

Elite Series 3X Guitar Rack in Driftwood Grey Finish
MODEL: GFW-ELITEGTR3RK-GRY

Elite 3X Guitar Rack in Maple Finish
MODEL: GFW-ELITEGTR3RK-MPL

Elite Series 5X Guitar Rack in Black Finish
MODEL: GFW-ELITEGTR5RK-BLK

Elite Series 5X Guitar Rack in Dark Walnut Finish
MODEL: GFW-ELITEGTR5RK-BRN

Elite Series 5X Guitar Rack in Driftwood Grey Finish
MODEL: GFW-ELITEGTR5RK-GRY

Elite Series 5X Guitar Rack in Maple Finish
MODEL: GFW-ELITEGTR5RK-MPL

6 SPACE GUITAR RACK

COLLAPSIBLE WOOD GUITAR RACK THAT HOLDS 6 GUITARS



FEATURED MODEL
GFW-GTR-WD6RK-MPL



- Elegantly Displays Multiple Guitars in Studio, Living Room, Showroom Floor, Classroom, or Similar Environment
- Fits up to (6) Electric or Acoustic Guitars
- Soft Padding on Base of Cradle Prevents Guitar Bottoms from Contacting Wood
- Sturdy 1"/25mm-Thick Laminated Plywood Construction with Textured Wood Grain Surface
- Collapsible Hideaway Design to Save Space or Transport When not in Use
- Safe for Standard Polyurethane Finishes, Not Tested for Compatibility with Vintage/Lacquer Finishes.
- Available in Natural Maple and Standard Black Colors



COLLAPSIBLE HIDEAWAY DESIGN



PADDED NECK CRADLE



SOFT PADDING ON BASE

Wooden 6X Guitar Rack in Standard Black Finish
MODEL: GFW-GTR-WD6RK-BLK

Wooden 6X Guitar Rack in Natural Maple Finish
MODEL: GFW-GTR-WD6RK-MPL

ELITE SERIES AMP STANDS

ELITE FURNITURE SERIES SMALL & LARGE ANGLED AMP STANDS



FEATURED MODEL
GFW-ELITEGTRAMPSM-GRY

FEATURED MODEL
GFW-ELITEGTRAMPLG-GRY

- Elegantly Displays Amp in Studio, Living Room, Showroom Floor, or Similar Environment
- Angles Amplifier Up Towards User for Improved Listening & Easier Access to Controls
- Reduces Sound Transfer into Floor by Lifting Amp from Ground
- Recessed Cable Channel & Added Standoff Depth for Placing Against Wall
- Sturdy 18mm-Thick Plywood Construction & EVA Foam Padding Safely Supports Amps up to 100 lbs./45 kg
- Fixed Height & 15-Degree Angled Position with 19"/483mm-Wide Amp Platform
- Cable Passthrough Cutout on Backrest Measures 17.5"/445mm (W) x 7.13"/ 181mm (H)
- Easy to Assemble



RECESSED CABLE CHANNEL



FOAM PADDING ALONG BACK



SITS FLAT AGAINST WALL

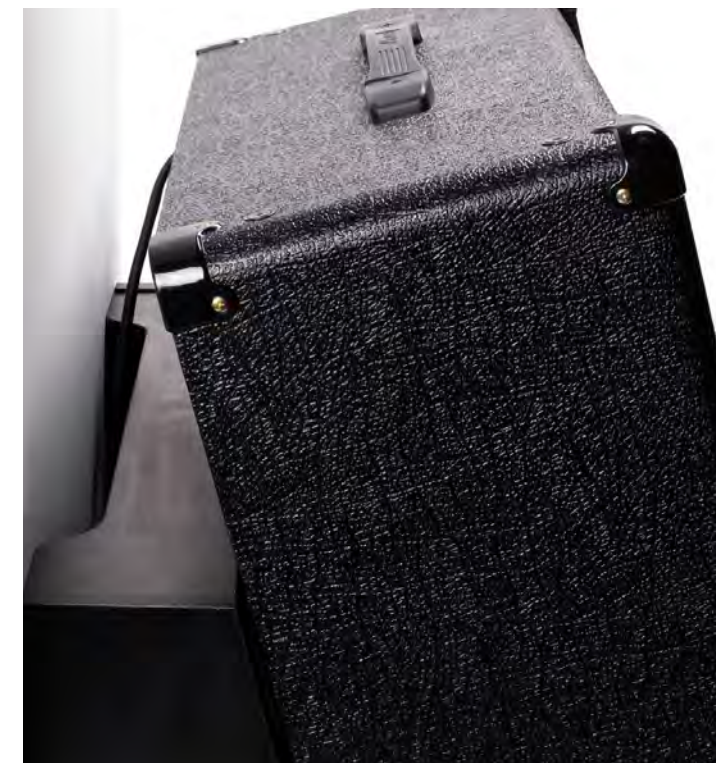

RECESSED CABLE CHANNEL



FEATURED MODEL
GFW-ELITEGTRAMPSM-BRN



FEATURED MODEL
GFW-ELITEGTRAMPLG-MPL



FEATURED MODEL
GFW-ELITEGTRAMPSM-BLK

Elite Series Small Amp Stand in Black Finish
MODEL: GFW-ELITEGTRAMPSM-BLK

Elite Series Small Amp Stand in Dark Walnut Finish
MODEL: GFW-ELITEGTRAMPSM-BRN

Elite Series Small Amp Stand in Driftwood Grey Finish
MODEL: GFW-ELITEGTRAMPSM-GRY

Elite Series Small Amp Stand in Maple Finish
MODEL: GFW-ELITEGTRAMPSM-MPL

Elite Series Large Amp Stand in Black Finish
MODEL: GFW-ELITEGTRAMPLG-BLK

Elite Series Large Amp Stand in Dark Walnut Finish
MODEL: GFW-ELITEGTRAMPLG-BRN

Elite Series Large Amp Stand in Driftwood Grey Finish
MODEL: GFW-ELITEGTRAMPLG-GRY

Elite Series Large Amp Stand in Maple Finish
MODEL: GFW-ELITEGTRAMPLG-MPL

ELITE SERIES KEYBOARD TABLE

ELITE FURNITURE SERIES 61-NOTE & 88-NOTE KEYBOARD TABLE



FEATURED MODEL
GFW-ELITEKEYTBL88-GRY

- 1"/25mm-Thick Double-Level Platform Design Fits Small Speakers, Keyboard & Accessories
- Flip-Top Design with Soft Close, Including Rear Cutout for Access to Cable Inputs & Controls
- Legs with Removable Inner Panel for Cable Routing & Under-Desk Cable Management Included
- Elegant & Compact Design for Small Apartments, Dorms, & Rooms with Limited Space

61-NOTE DIMENSIONS

- Upper Platform Dimensions: 42"/1067mm x 8"/203mm
- Lower Platform Dimensions: 40.5"/1029mm x 15"/381mm, Height Clearance: 6"/152mm
- Product Dimensions (Compact Overall): 42"/1067mm (L) x 16"/406mm (W) x 32"/813mm (H), Net Weight: 33.6 lbs./15.2 kg

88-NOTE DIMENSIONS

- Upper Platform Dimensions: 60"/1524mm x 8"/203mm
- Lower Platform Dimensions: 58.5"/1486mm x 15"/381mm, Height Clearance: 6"/152mm
- Product Dimensions (Compact Overall): 60"/1524mm (L) x 16"/406mm (W) x 32"/813mm (H), Net Weight: 52.3 lbs./23.7 kg



FLIP TOP DESIGN

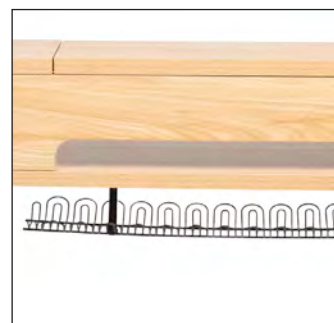

UNDER TABLE CABLE MANAGEMENT



REAR CUTOUT FOR CABLES



CABLE ROUTING IN LEGS



FEATURED MODEL
GFW-ELITEKEYTBL61-MPL



FEATURED MODEL
GFW-ELITEKEYTBL61-BLK



FEATURED MODEL
GFW-ELITEKEYTBL88-BRN



Elite Series Keyboard Table in Black Finish
MODEL: GFW-ELITEKEYTBL61-BLK



Elite Series Keyboard Table in Dark Walnut Finish
MODEL: GFW-ELITEKEYTBL61-BRN



Elite Series Keyboard Table in Driftwood Grey Finish
MODEL: GFW-ELITEKEYTBL61-GRY



Elite Series Keyboard Table in Maple Finish
MODEL: GFW-ELITEKEYTBL61-MPL



Elite Series Keyboard Table in Black Finish
MODEL: GFW-ELITEKEYTBL88-BLK



Elite Series Keyboard Table in Dark Walnut
MODEL: GFW-ELITEKEYTBL88-BRN



Elite Series Keyboard Table in Driftwood Grey Finish
MODEL: GFW-ELITEKEYTBL88-GRY



Elite Series Keyboard Table in Maple Finish
MODEL: GFW-ELITEKEYTBL88-MPL

ELITE SERIES SYNTH OASIS

FOR 32-KEY MIDI CONTROLLERS



**Elite Series Synth Oasis
in Maple Finish**
MODEL: GFW-ELITE-SYNTHOASIS-MPL-32

- Accommodates gear up to 21" wide, ideal for desktop synths, drum machines, samplers, audio interfaces, and effects pedals
- Elegant black wood frame with a durable metal upper rack that tilts up to 20° for improved visibility and playing comfort
- Rear rack space supports power supplies and audio gear, while integrated cable routing holes keep your setup clean and organized
- Comes complete with a heavy-duty gig bag, 3M Dual Lock, and zip ties for secure transport and professional-level mounting



INCLUDES:
Heavy-Duty Gig Bag, Dual Lock, and Zip Ties for Secure Gear Mounting



WIDTH
15"/381 mm



LENGTH
21"/533.4 mm



**Elite Series Synth Oasis
in Driftwood Grey Finish**
MODEL: GFW-ELITE-SYNTHOASIS-GRY-32



**Elite Series Synth Oasis
in Black Finish**
MODEL: GFW-ELITE-SYNTHOASIS-BLK-32



ADJUSTABLE UPPER RACK
TILTS UP TO 20 DEGREES

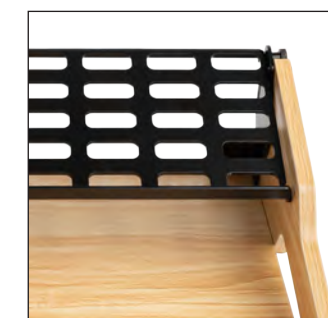

HOLES IN THE UPPER RACK FOR
CLEAN AND ORGANIZED SETUP



REAR RACK SPACE

GUITAR

Guitarists, more than any other musician, value the advantages of protection and storage for their gear. Guitars, amps, effects and accessories all need safe transport. Luckily, Gator's got you covered. Oh, and our pedal boards are amazing too.



GATOR GUITAR
MINI VAULT
PAGE 30

GUITAR CASES.....	24	GUITAR SEATS.....	74
GUITAR BAGS.....	46	PEDAL BOARDS.....	76
ACCESSORIES.....	62	POWER SUPPLY.....	88
GUITAR STANDS.....	64	AMP ACCESSORIES.....	95

TITAN SERIES GUITAR ROAD CASES

TITAN SERIES CASE DESIGNED TO FIT SINGLE CUT-AWAY GUITARS



TITAN SERIES

FEATURED MODEL
GWP-LP

- Fits "Jazz" or "Precision" Style Bass Guitars (GWP-BASS), "Strat" or "Tele" Style Electric Guitars (GWP-ELECTRIC), PRS Single/Double Cutaway Guitars (GWP-PRS)
- Fits both left and right handed single cutaway electrics such as Gibson Les Paul® (GWP-LP)
- Fits right handed style (GWP-BASS) or both left and right handed style (GWP-ELECTRIC)
- UltraGuard™ Technology Secure from elements with IP 67 and Mil-STD-810F Immersion Test Certification (GWP-PRS)
- **RUGGED, LIGHTWEIGHT PROTECTION:** Impact-proof NK-7™ resin construction with ATA-300 certification and IP67 water & dust resistance.
- **MILITARY-GRADE SEALING:** Mil-STD-810F immersion tested with a pressure release valve for altitude changes.
- **SECURE & EASY ACCESS:** PowerClaw™ latching system with easy release and pad-lockable security.
- **COMFORTABLE PORTABILITY:** Soft-grip handle, built-in wheels, and extendable tow-handle for effortless transport.
- **ORGANIZED INTERIOR:** Ample storage compartments lined with plush blue crushed velvet.
- **TRAVEL-READY DURABILITY:** Designed to withstand extreme conditions without sacrificing style or function.



AUTOMATIC PRESSURE RELEASE VALVE



CASE STRAP HOOKS

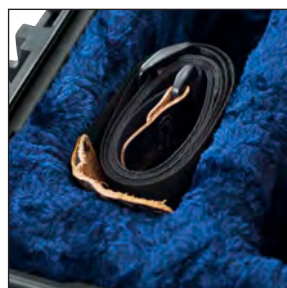

INTERNAL STORAGE



VELVET INTERIOR



Water and Dust-Proof Case with IP67 Certification

Plush Lined Foam Padded Interior With Storage Compartment

Built-In Wheels and Tow-Handle

Easy Release Powerclaw™ Latching System

Soft-Grip Comfort Handle

FEATURED MODEL
GWP-PRS

Titan Series Strat/Tele Style Guitar Road Case
MODEL: GWP-ELECTRIC

Titan Series Gibson Les Paul® Guitar Road Case
MODEL: GWP-LP

Titan Series J/P Bass Style Guitar Road Case
MODEL: GWP-BASS

Titan Series PRS Guitar Road Case
MODEL: GWP-PRS



WATER PROOF



IMPACT RESISTANT



DUST PROOF

TITAN SERIES GUITAR ACCESSORY CASE

LINE 6 HELIX STADIUM & STADIUM XL

NEW!

- Custom foam insert nest stabilizes your modeler securely to prevent movement, impact damage, and wear during travel or storage.
- IP67 certified waterproof and dustproof design with MIL-STD-810F immersion test certification ensures worry-free performance in extreme conditions.
- Tough, durable, and built to protect your gear through the rigors of air travel, ensuring long-lasting performance and reliable protection.
- Rugged NK-7™ resin shell with PowerClaw™ latching system, soft-grip comfort handle, reinforced metal pad-lockable compatibility, and foam-filled lid for complete safety and ease of use.

Titan Series Case for Line 6 Helix Stadium Floor
MODEL: GWP-L6STADIUMXL



Titan Series Case for Line 6 Helix Stadium XL Floor
MODEL: GWP-L6STADIUMXL-W

Titan Series Case for Line 6 Helix Stadium Floor
MODEL: GWP-L6STADIUM

FREQUENT FLYER TSA SERIES

TSA SERIES ATA MOLDED POLYETHYLENE GUITAR CASE FOR GUITARS



- ATA molded military grade polyethylene outer-shell
- TSA accepted locking center latch ideal for air travel
- Universal fit EPS protective foam interior nest
- Thick black plush interior
- Extended reach protective neck cradle
- Ergo-grip injection molded handle
- Surface mounted impact diversion latch housing & red release trigger
- Black powder coated hardware and continuous valance
- Ample internal storage compartments



FEATURED MODEL
G TSA-GTRBASS



FEATURED MODEL
G TSA-GTRDREAD



FEATURED MODEL
G TSA-HEADLESS-ELEC



TSA LOCKING CENTER LATCH



RED RELEASE TRIGGER



COMFORTABLE HANDLE



PLUSH PROTECTIVE INTERIOR

TSA ATA Molded Acoustic Guitar Case
MODEL: G TSA-GTRDREAD

TSA ATA Molded Classical Guitar Case
MODEL: G TSA-GTRCLASS

TSA ATA Molded Electric Guitar Case
MODEL: G TSA-GTRELEC

TSA ATA Molded Gibson SG® Guitar Case
MODEL: G TSA-GTRSG

TSA ATA Molded Gibson Les Paul® Guitar Case
MODEL: G TSA-GTRLPS

TSA ATA Molded Semi-Hollow Guitar Case
MODEL: G TSA-GTR335

TSA ATA Molded Bass Guitar Case
MODEL: G TSA-GTRBASS

TSA ATA Molded Headless Guitar Case
MODEL: G TSA-HEADLESSELEC

FREQUENT FLYER TSA SERIES; LED EDITION

TSA SERIES ATA MOLDED POLYETHYLENE GUITAR CASE FOR GUITARS



- Unique interior LED light feature to illuminate storage compartment and guitar
- Military grade polyethylene exterior for impact-resistant protection
- TSA-accepted locks for hassle-free travel
- Black plush interior to guard against scratches and dents
- Extended reach protective neck cradle
- Push-button release latches are impact resistant for extra durability
- Ergo-grip molded handles for comfort
- Special LED edition badge on exterior

TSA ATA Molded Electric Guitar Case with LED Light
MODEL: GTSA-GTRELEC-LED

TSA ATA Molded Bass Guitar Case with LED Light
MODEL: GTSA-GTRBASS-LED



FREQUENT FLYER TSA SERIES

TSA SERIES ATA MOLDED POLYETHYLENE CASE FOR NEURAL QUAD CORTEX

- ABS Construction with Soft, EVA and PU Foam Interior
- Red Tricot-Lined Interior
- Black Valences & Quick-Release Draw Latches
- TSA Accepted Locking Latch Ideal for Air Travel
- Flexible Bottom Layer Can Accommodate Either Two Expression Pedals and The Power Supply or One Expression Pedal, Power Supply, and Accessories

Extra Large TSA Case for Neural Quad Cortex
MODEL: GTSA-GTR-QCXL

TSA Case for Neural Quad Cortex
MODEL: GTSA-GTR-QC1



FREQUENT FLYER TSA SERIES

TSA SERIES ATA MOLDED POLYETHYLENE CASE DESIGNED TO FIT MINI AMP MODELERS

NEW!

- ABS Construction with Soft, EVA and PU Foam Interior
- Configurable interior foam nest
- TSA approved latches
- Polyethelene exterior

TSA Case for Popular Mini Amp Modelers
MODEL: GTSA-GTR-MINIAMPMOD



MINI VAULT GUITAR CASE

ROTOMOLDED RACK CASE FOR TWO ELECTRIC OR BASS GUITARS



Mini Vault for 2 Electric Guitars
MODEL: GTR-MINIVAULT-E2R2

Mini Vault for 2 Electric Bass Guitars
MODEL: GTR-MINIVAULT-B2

- Built Tough: Roto-Molded Polyethylene Plastic Outer Shell Keeps Guitars Protected Against Damage
- Luggage-Friendly & Road-Ready with Thick, Interior Foam Walls to Keep Instruments Safe
- GTR-MINIVAULT-E2R2 - Fits Two (2) Electric Guitars, Including Les Paul, Stratocaster, Telecaster, Jazzmaster/Offset, PRS, & Similar-Style Guitars
- GTR-MINIVAULT-B2 - Fits Two (2) Electric Bass Guitars, Including Precision, Jazz, and Stingray Similar-Style bass guitars
- Does Double Duty as Guitar Rack for Keeping Instruments Side-Stage for Easy Access
- Strong Magnets Keep Lid Conveniently Attached to Rear of Case When Used as a Guitar Rack
- Butterfly-Style Twist Latches Keep Lid Secured to Case During Movement
- Ergonomic Grip Handle on Front for Easy Loading & Unloading
- Made in the USA

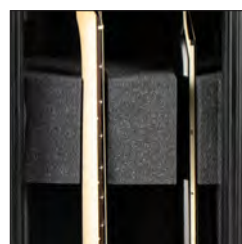

INTERIOR FOAM



TWIST LATCHES

G-TOUR SERIES - GUITAR ROAD CASES

ATA WOOD FLIGHT CASE FOR GUITARS

- Heavy-duty plywood construction with laminated exterior
- Reinforced ball corners
- Red recessed twist latches
- Spring-loaded, rubber-gripped handles
- Heavy-duty commercial grade plated hardware
- Tongue and groove extrusion aluminum valance
- Black plush interior



EXTRA STORAGE SPACE



BALL CORNERS

Electric Guitar Flight Case
MODEL: G-TOUR ELEC

Bass Guitar Flight Case
MODEL: G-TOUR BASS

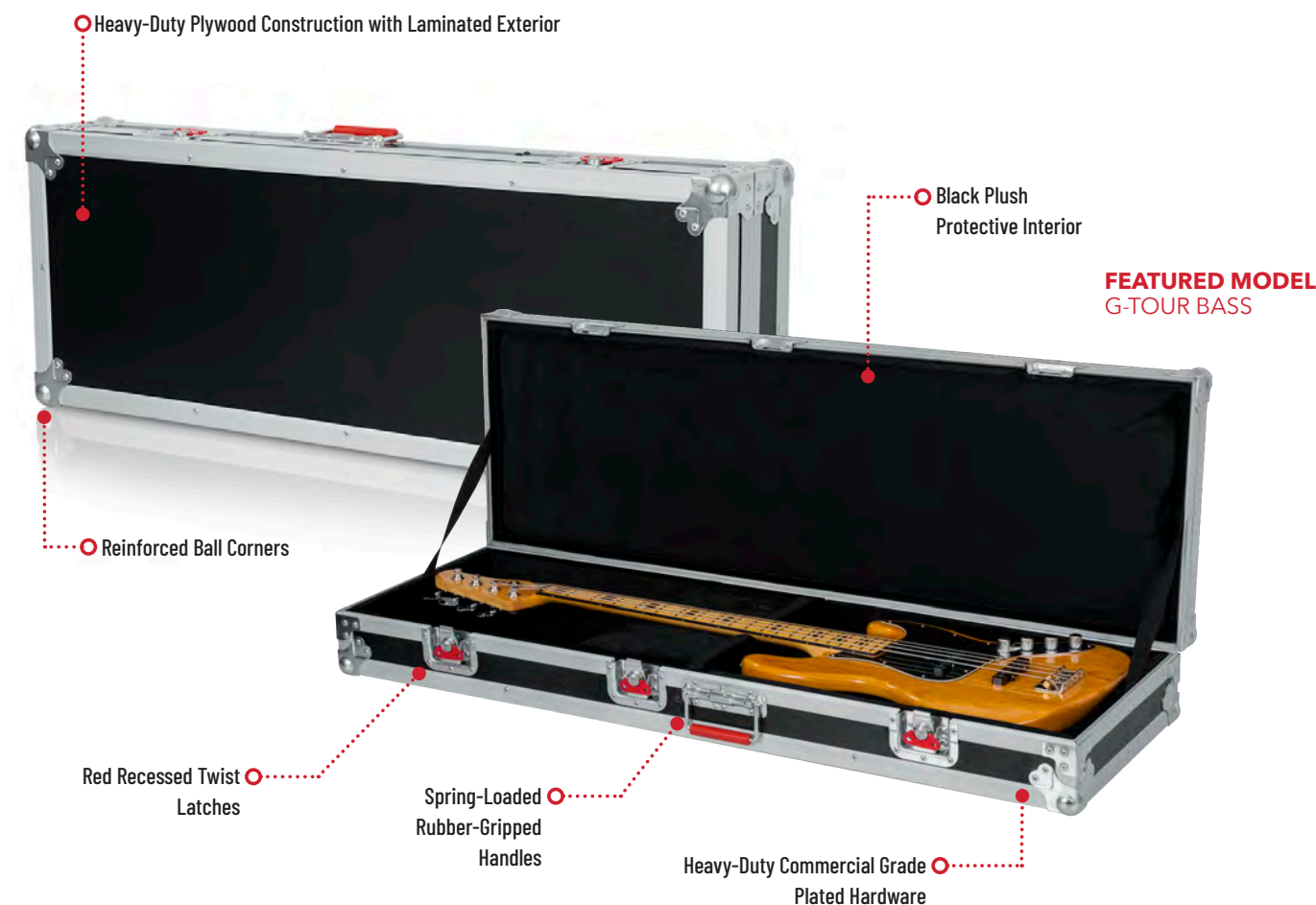

FEATURED MODEL
G-TOUR BASS

LEGACY SERIES DELUXE GUITAR CASES

DELUXE MOLDED CASES FOR GUITARS



FEATURED MODEL
GC-JMASTER

- Hard outer shell molded from impact-resistant ABS plastic for an ultra-durable exterior
- EPS foam and plush lining provide a protective interior safe from nicks and scratches
- Spacious interior storage compartment offers secure hideaways for capos, strings, picks and accessories
- Reinforced extra strength handles offer a firm grip
- Heavy-duty aluminum valances keep the closure aligned while protecting the outer edges and reinforcing the overall strength of the case
- Chrome plated lockable latches keep your instrument securely in place at all times



CHROME PLATED LOCKABLE LATCH



EPS FOAM AND PLUSH LINING



EXTRA STRENGTH HANDLES



IMPACT-RESISTANT ABS PLASTIC



FEATURED MODEL
GC-DREAD

Molded APX-Style Guitar Case
MODEL: GC-APX

Molded Dreadnought Guitar Case
MODEL: GC-DREAD

Molded 12-String Dreadnought Guitar Case
MODEL: GC-DREAD-12

Molded Classical Guitar Case
MODEL: GC-CLASSIC

Molded Jumbo Acoustic Guitar Case
MODEL: GC-JUMBO

Molded Banjo Case
MODEL: GC-BANJO-XL

Molded Jazzmaster Style Guitar Case
MODEL: GC-JMASTER



FEATURED MODEL
GC-BANJO-XL



FEATURED MODEL
GC-DREAD-12



FEATURED MODEL
GC-DEEPCBOWL

FEATURED MODEL
GC-PARLOR

FEATURED MODEL
GC-MANDOLIN

Molded Mandolin Case

MODEL: GC-MANDOLIN

Molded Electric Guitar Case

MODEL: GC-ELECTRIC-A

Molded Extra Long Electric Guitar Case

MODEL: GC-ELEC-XL

Molded Gibson Les Paul® Guitar Case

MODEL: GC-LPS

Molded Gibson SG® Guitar Case

MODEL: GC-SG

Molded Semi-Hollow Style Guitar Case

MODEL: GC-335

Molded Taylor GS-Mini Guitar Case

MODEL: GC-GSMINI

Molded Bass Guitar Case

MODEL: GC-BASS

Molded Deep Contour/ Round-Back Guitar Case

MODEL: GC-DEEP BOWL

Molded Gibson Les Paul® Guitar Case

MODEL: GC-LPS

Molded Gibson SG® Guitar Case

MODEL: GC-SG

Molded Semi-Hollow Style Guitar Case

MODEL: GC-335

Molded Parlor Guitar Case

MODEL: GC-PARLOR



FEATURED MODEL
GC-ELECTRIC-A



FEATURED MODEL
GC-335

LEGACY SERIES; LED EDITION

DELUXE MOLDED PLASTIC GUITAR CASE FOR GUITARS WITH BUILT-IN LED LIGHT



LED edition
GUITAR CASES

FEATURED MODEL
GC-ELEC-LED

- Heavy-duty ABS plastic exterior to resist impact, dust and dirt
- Fitted EPS foam interior to protect against scratches and damage
- Interior LED light illuminates storage pockets next to guitar
- Extra-strength handles offer a firm grip
- Heavy-duty aluminum valances protect the case's alignment and structure
- Secured latches lock to keep your instrument safe at all times
- Special LED Edition badge on the exterior of the case

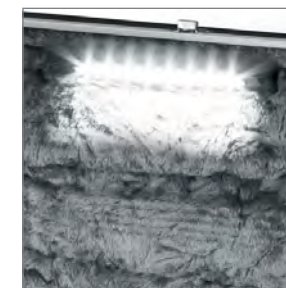

INTERIOR LED LIGHT



FEATURED MODEL
GC-BASS-LED

Molded Electric Guitar Case with LED Light

MODEL: GC-ELEC-LED

Molded Bass Guitar Case with LED Light

MODEL: GC-BASS-LED

TRADITIONAL DELUXE WOOD SERIES

DELUXE WOOD CASES FOR GUITARS



FEATURED MODEL
GW-LPS

- Rugged plywood construction
- Plush lined foam padded interior with storage compartment
- Lockable with ergonomically designed padded carrying handle
- Contrast stitching
- Triple chrome-plated hardware

Bass Guitar Deluxe Wood Case
MODEL: GW-BASS

Explorer Guitar Deluxe Wood Case
MODEL: GW-EXP

Classical Guitar Deluxe Wood Case
MODEL: GW-CLASSIC

Jaguar Style Guitar Deluxe Wood Case
MODEL: GW-JAG

Flying V Guitar Deluxe Wood Case
MODEL: GW-FLYV

Dreadnought Guitar Deluxe Wood Case
MODEL: GW-DREAD

Jumbo Acoustic Guitar Deluxe Wood Case
MODEL: GW-JUMBO

Deluxe Wood Case for Electric Guitars
MODEL: GW-ELECTRIC

Gibson Les Paul® Guitar Deluxe Wood Case
MODEL: GW-LPS

FEATURED MODEL
GW-FLYV



TRADITIONAL DELUXE SERIES; BROWN

DELUXE WOOD CASES FOR GUITAR; VINTAGE BROWN EXTERIOR



FEATURED MODEL
GW-SG-BROWN

- Rugged plywood construction
- Plush lined foam padded interior with storage compartment
- Lockable with ergonomically designed padded carrying handle
- Gold-plated hardware
- Traditional brown exterior
- Plush magenta interior with interior cover



PLUSH MAGENTA INTERIOR

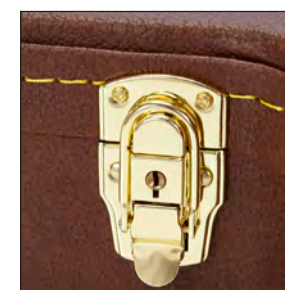

GOLD-PLATED HARDWARE



FEATURED MODEL
GW-335-BROWN

Semi-Hollow Guitar Deluxe Wood Case, Brown
MODEL: GW-335-BROWN

Gibson Les Paul® Guitar Deluxe Wood Case, Brown
MODEL: GW-LP-BROWN

Gibson SG® Guitar Deluxe Wood Case, Brown
MODEL: GW-SG-BROWN

TRADITIONAL DELUXE SERIES; VINTAGE BROWN

DELUXE WOOD CASE FOR ELECTRIC GUITARS; VINTAGE BROWN EXTERIOR



Electric Guitar Deluxe Wood Case, Vintage Brown
MODEL: GW-ELECT-VIN

- Rugged plywood construction
- Plush lined foam padded interior with storage compartment
- Lockable with ergonomically designed padded carrying handle
- Gold-plated hardware
- Distressed leather-like finish

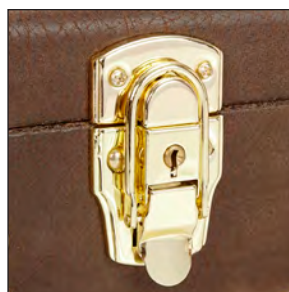

GOLD FINISH LATCHES



PLUSH LINED INTERIOR



PADDED CARRY HANDLE

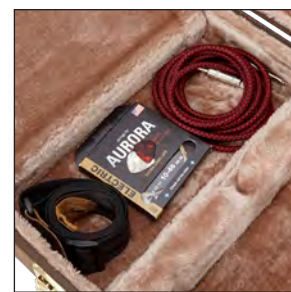

INTERIOR STORAGE COMPARTMENT

TRADITIONAL DELUXE SERIES; TWEED

DELUXE WOOD CASE FOR ELECTRIC GUITARS; TWEED



Electric Guitar Deluxe Wood Case; Tweed
MODEL: GW-ELECTIC-TW

- Rugged plywood construction
- Plush lined foam padded interior with storage compartment
- Lockable with ergonomically designed padded carrying handle
- Gold-plated hardware



PADDED CARRY HANDLE



INTERIOR STORAGE COMPARTMENT

JOURNEYMAN SERIES

DELUXE WOOD CASE FOR GUITARS; JOURNEYMAN BURLAP EXTERIOR



FEATURED MODEL
GW-JM UKE-CON

- Heavy-duty plywood panels and traditional craftsmanship create a durable outer shell
- Pebble weave burlap exterior and brown espresso trim evokes an elegant vintage style
- Antique brass hardware, with a locking latch, provides the finishing touch on the case's retro sophistication
- Pebble weave burlap exterior with espresso trim
- Royal blue crushed velvet lining cradles your instrument in safety
- Spacious internal storage compartment with a lid keeps accessories organized
- Removable interior pad offers added versatility and guarantees a snug fit (GW-JM BANJO XL)
- Removable shoulder strap offers versatility and ensures comfortable transportation (GW-JM UKE-CON, GW-JM UKE-SOP, GW-JM UKE-TEN)



GW-JM MANDOLIN

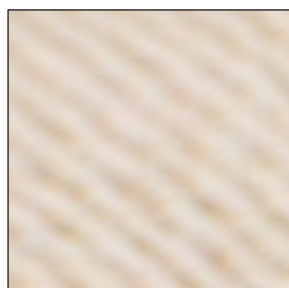

ANTIQUÉ BRASS HARDWARE



PADDED COMFORT HANDLE

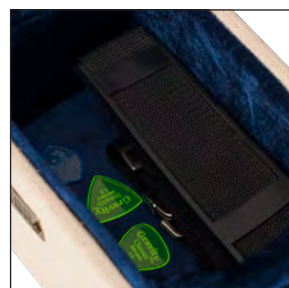

INTERIOR STORAGE

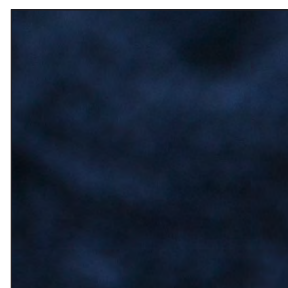

CRUSHED VELVET INTERIOR



FEATURED MODEL
GW-JM ELEC

FEATURED MODEL
GW-JM DREAD

**Journeyman Semi-Hollow
Electrics Deluxe Wood Case**
MODEL: GW-JM 335

**Journeyman Banjo
Deluxe Wood Case**
MODEL: GW-JM BANJO XL

**Journeyman Bass Guitar
Deluxe Wood Case**
MODEL: GW-JM BASS

**Journeyman Dreadnaught
Acoustic Deluxe Wood Case**
MODEL: GW-JM DREAD

**Journeyman Electric
Guitar Deluxe Wood Case**
MODEL: GW-JM ELEC

**Journeyman Les Paul®
Deluxe Wood Case**
MODEL: GW-JM LPS

**Journeyman Mandolin
Deluxe Wood Case**
MODEL: GW-JM MANDOLIN

**Journeyman Resonator
Guitar Deluxe Wood Case**
MODEL: GW-JM RESO

**Journeyman Concert Style
Ukulele Deluxe Wood Case**
MODEL: GW-JM UKE-CON

**Journeyman Soprano Style
Ukulele Deluxe Wood Case**
MODEL: GW-JM UKE-SOP

**Journeyman Tenor Style
Ukulele Deluxe Wood Case**
MODEL: GW-JM UKE-TEN

TRADITIONAL SERIES

HARD-SHELL WOOD CASE FOR GUITARS

NEW SIZES!



FEATURED MODEL
GWE-339

- Ultra-durable plywood construction stands up to years of use and abuse
- Black Tolex PVC covering creates a moisture-resistant, rugged exterior
- Ergonomic handle offers a comfortable grip, perfectly balancing the weight of your instrument
- Thick plush lining keeps your guitar cushioned against impact
- Spacious interior accessory compartment organizes all your favorite guitar accessories, while providing additional neck support
- Chrome plated lockable latches secure the case



FEATURED MODEL
GWE-ELEC-WIDE



INTERIOR STORAGE



LOCKABLE LATCHES



PADDED CARRY HANDLE



NECK CRADLE



Ergonomically Designed Padded Carrying Handle

Durable Plywood Construction

Plush Lined Foam Padded Interior

FEATURED MODEL
GWE-ELEC

FEATURED MODEL
GWE-CLASSIC

Chrome Plated Hardware And Lockable Latches

FEATURED MODEL
GWE-TODFHRN

Internal Accessory Compartment

NEW!
339-Style Guitar Wood Case
MODEL: GWE-339

Martin 000 Acoustic Guitar Wood Case MODEL: GWE-000AC	Semi-Hollow Style Guitar Wood Case MODEL: GWE-335	3/4 Sized Acoustic Wood Case MODEL: GWE-ACOU-3/4	Bass Guitar Wood Case MODEL: GWE-BASS
Classical Guitar Wood Case MODEL: GWE-CLASSIC	12 String Dreadnought Guitar Wood Case MODEL: GWE-DREAD 12	Electric Guitar Wood Case MODEL: GWE-ELEC	PRS Style & Wide Body Electric Case MODEL: GWE-ELEC-WIDE
Extreme Guitar Wood Case MODEL: GWE-EXTREME	Jaguar Style Guitar Wood Case MODEL: GWE-JAG	Gibson Les Paul® Guitar Wood Case MODEL: GWE-LPS-BLK	Thunderbird Bass Guitar Wood Case MODEL: GWE-TBIRD-BASS
Concert Ukulele Wood Case MODEL: GWE-UKE-CON	Soprano Ukulele Wood Case MODEL: GWE-UKE-SOP	Tenor Ukulele Wood Case MODEL: GWE-UKE-TEN	Wood Case for Ibanez Tim Henson Style Guitar MODEL: GWE-TODFHR

LEGACY HYBRID SERIES

RIGID EPS POLYFOAM LIGHTWEIGHT CASE FOR GUITARS



- Hybrid case style, offering the best of both worlds: the portability of a gig bag meets the sturdy protection of a hard-shell case
- Rugged, 600-Denier nylon exterior forms a durable, water-resistant outer shield
- Dense EPS Foam core and plush lining keeps your guitar safe from bumps and scratches
- 2 Spacious interior storage compartments offer secure hideaways for capos, strings, picks, and accessories
- Heavy-duty nylon web carry handle gives you a firm grip
- Removable shoulder strap makes it comfortable and easy to take your case on the road



BACKPACK STRAPS



SECURE NECK CRADLE WITH INTERIOR STORAGE



INTERIOR STORAGE



EXTERNAL STORAGE POCKETS



12 String Dreadnought Guitar Lightweight Case
MODEL: GL-DREAD-12

Classical Guitar Lightweight Case
MODEL: GL-CLASSIC

Jumbo Acoustic Guitar Lightweight Case
MODEL: GL-JUMBO

APX-Style Guitar Lightweight Case
MODEL: GL-APX

Acoustic Bass Guitar Lightweight Case
MODEL: GL-AC-BASS

Banjo Lightweight Case
MODEL: GL-BANJO XL

Lightweight Mandolin Case
MODEL: GL-MANDOLIN

Electric Guitar Lightweight Case
MODEL: GL-ELECTRIC

Gibson Les Paul® Guitar Lightweight Case
MODEL: GL-LPS

Gibson SG® Guitar Lightweight Case
MODEL: GL-SG

Bass Guitar Lightweight Case
MODEL: GL-BASS

ICON™ SERIES GIG BAGS

FEATURED MODEL
G-ICONBASS

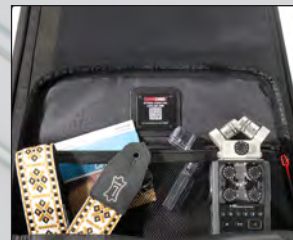

LARGE ACCESSORIES POCKET



HIDDEN BACK POCKET



ADJUSTABLE NECK
SUPPORT BLOCK



POP-OUT LUGGAGE TAG

- Multi-layered semi-rigid construction with weather-resistant 1000D black nylon exterior fabric and soft interior lined with red micro-velvet fabric
- Hideaway backpack straps with bottle opener and stowaway D-ring pockets on base of bag for clean appearance
- Exterior pop-out luggage tag and interior serialized bag tracker with laser-etched QR code for quick registration/identification
- Removable, adjustable neck support block with hook-and-loop wrap for stability during transport; interior body blocks for increased protection
- Large pocket with keyring clip stores cables, strings & other accessories; 16.5 x 13" (419/330mm)
- Hidden pocket on back for quick access to passport, wallet, smartphone and other personal items; small and medium-sized exterior pockets also included
- TSA luggage lock-friendly zipper pulls on main guitar compartment for seamless airport travel
- Rubber bumpers & reinforced, padded grab handles located on front, back and side for various carry modes
- Stylish rain cover with dedicated storage pocket



FEATURED MODEL
G-ICONLP

Red Micro-Velvet Fabric

Adjustable Neck
Support Block



Icon Series Gig Bag for
Electric Guitars
MODEL: G-ICONELECTRIC

Icon Series Gig Bag for
Dreadnaught Guitars
MODEL: G-ICONDREAD

Icon Series Gig Bag for
Bass Guitars
MODEL: G-ICONBASS

Icon Series Gig Bag for
335 Style Guitars
MODEL: G-ICON335

Icon Series Gig Bag for
Les Paul Style Guitars
MODEL: G-ICONLP

ICON COLOR SERIES

GUITAR GIG BAG WITH MICRO FLEECE INTERIOR AND REMOVABLE BACKPACK STRAPS



ICON™ COLOR



FEATURED MODEL
G-ICON335-BLU



FEATURED MODEL
G-ICONBASS-GRY



FEATURED MODEL
G-ICONELECTRIC-KHK



FEATURED MODEL
G-ICONDREAD-GRN

Icon Series Gig Bag for 335 Style Guitars in Blue
MODEL: G-ICON335-BLU

Icon Series Gig Bag for 335 Style Guitars in Green
MODEL: G-ICON335-GRN

Icon Series Gig Bag for 335 Style Guitars in Grey
MODEL: G-ICON335-GRY

Icon Series Gig Bag for 335 Style Guitars in Khaki
MODEL: G-ICON335-KHK

Icon Series Gig Bag for Bass Guitars in Blue
MODEL: G-ICONBASS-BLU

Icon Series Gig Bag for Bass Guitars in Green
MODEL: G-ICONBASS-GRN

Icon Series Gig Bag for Bass Guitars in Grey
MODEL: G-ICONBASS-GRY

Icon Series Gig Bag for Bass Guitars in Khaki
MODEL: G-ICONBASS-KHK

Icon Series Gig Bag for Dreadnought Guitars in Blue
MODEL: G-ICONDREAD-BLU

Icon Series Gig Bag for Dreadnought Guitars in Green
MODEL: G-ICONDREAD-GRN

Icon Series Gig Bag for Dreadnought Guitars in Grey
MODEL: G-ICONDREAD-GRY

Icon Series Gig Bag for Dreadnought Guitars in Khaki
MODEL: G-ICONDREAD-KHK

Icon Series Gig Bag for Electric Guitars in Blue
MODEL: G-ICONELECTRIC-BLU

Icon Series Gig Bag for Electric Guitars in Green
MODEL: G-ICONELECTRIC-GRN

Icon Series Gig Bag for Electric Guitars in Grey
MODEL: G-ICONELECTRIC-GRY

Icon Series Gig Bag for Electric Guitars in Khaki
MODEL: G-ICONELECTRIC-KHK

ICON SERIES TAKE TWO BAGS

HIGH QUALITY GIG BAGS DESIGNED SPECIFICALLY FOR CARRYING TWO GUITARS



- Multi-layered semi-rigid construction with weather-resistant 1000D black nylon exterior fabric and soft interior lined with red micro-velvet fabric
- Hideaway backpack straps with bottle opener and stowaway D-ring pockets on base of bag for clean appearance
- Exterior pop-out luggage tag and interior serialized bag tracker with laser-etched QR code for quick registration/identification
- Removable, adjustable neck support block with hook-and-loop wrap for stability during transport; interior body blocks for increased protection
- Large pocket with keyring clip stores cables, strings & other accessories; 16.5 x 13" (419/330mm)
- Hidden pocket on back for quick access to passport, wallet, smartphone and other personal items; small and medium-sized exterior pockets also included
- TSA luggage lock-friendly zipper pulls on main guitar compartment for seamless airport travel
- Rubber bumpers & reinforced, padded grab handles located on front, back and side for various carry modes
- Stylish rain cover with dedicated storage pocket



Icon Series Take Two Gig Bag for (2) Bass Guitars
MODEL: G-ICONTBASS-BLK

ICON SERIES ELECTRIC GUITAR BAG

STANDARD ELECTRIC GUITAR AND LINE 6 STADIUM XL AMP MODELER

NEW!



- **SECURE GUITAR STORAGE:** Fits most standard-shaped electric guitars with a removable, adjustable neck support block and interior body blocks to keep your guitar stable and protected during transport.
- **POCKET FOR LINE 6 STADIUM XL:** External pocket designed for the Line 6 Stadium XL with pocket dimensions of 21.5" x 10.5" x 3.5" (L x W x H) (54.6 x 26.7 x 8.9 cm (L x W x H)). Also fits many other multi-effects pedals or small pedalboards.
- **DURABLE PROTECTIVE CONSTRUCTION:** Weather-resistant 1000D nylon exterior, 1" foam padding, reinforced ABS carry handle, Hypalon grab handles, and soft micro-velvet interior.
- **TRAVEL-READY DESIGN:** Multiple carry handles with hideaway backpack straps, heavy-duty main zipper pulls, multiple exterior pockets for accessories, and an elastic luggage tag for easy travel.



ICON Bag for Electric Guitar and Line 6 Stadium XL
MODEL: G-ICON-ELEC-L6STADIUMXL

PRO-GO SERIES

GUITAR GIG BAG WITH MICRO FLEECE INTERIOR AND REMOVABLE BACKPACK STRAPS



FEATURED MODEL
G-PG-ACOUSTIC

- Ultra-thick padded sidewalls
- Micro-fleece interior
- Protective rain cover
- Multi-adjustable, removable backpack straps
- Body block internal shock absorber
- Tablet pocket
- Internal cable management
- Sheet music pocket



FEATURED MODEL
G-PG-ELECTRIC



INTERNAL SHOCK ABSORBER



ACCESSORY POCKET WITH
CABLE MANAGEMENT



CABLE MANAGEMENT



BUILT-IN HIDE-AWAY
RAIN COVER



FEATURED MODEL
G-PG-335V



FEATURED MODEL
G-PG-UKE-CON



FLYING V & 335 SEMI-HOLLOW STYLE GUITARS

**Pro-Go Acoustic
Gig Bag**
MODEL: G-PG ACOUSTIC

**Pro-Go Acoustic/Electric
Double Gig Bag**
MODEL: G-PG-ACOULECT

**Pro-Go Classical
Gig Bag**
MODEL: G-PG CLASSIC

**Pro-Go 335/Flying
V Guitar Gig Bag**
MODEL: G-PG-335V

**Pro-Go Electric
Guitar Gig Bag**
MODEL: G-PG ELECTRIC

**Pro-Go Electric Guitar
Double Gig Bag**
MODEL: G-PG ELEC 2X

**Pro-Go Bass
Guitar Gig Bag**
MODEL: G-PG BASS

**Pro-Go Bass Guitar Dou-
ble Gig Bag**
MODEL: G-PG BASS 2X

**Pro-Go Tenor
Ukulele Gig Bag**
MODEL: G-PG-UKE-TEN

TRANSIT SERIES

GUITAR GIG BAGS

- Weather resistant blended fabric exterior
- Thick rubber tread on bottom of the bag prevents wear and protects from small puddles to spilled drinks
- 3/4" Thick foam padding covered with plush micro-fleece lining
- Rigid interior construction within the frame of the bag for case-like protection
- Adjustable, removable three-point interior padding system protects the headstock, neck and bottom/endpin
- Large front zippered pocket with flap, features G-hook buckle and seatbelt loops for multiple connection points allowing you to fill the pocket to capacity and still secure it
- Small pocket on front flap with soft lining for electronics provides quick access to phone, keys and small electronics
- Molded, padded, contoured handle for a secure yet comfortable grip
- Padded, removable, color matched backpack straps
- Several D-rings for clipping accessories

FEATURED MODEL
GT-ACOUSTIC-TAN

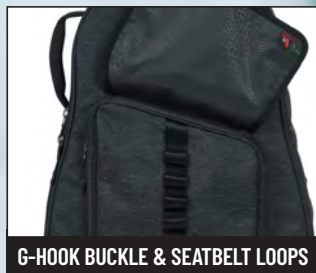

G-HOOK BUCKLE & SEATBELT LOOPS



THICK RUBBER TREAD



FRONT POCKET WITH FLAP



FEATURED MODEL
GT-UKE-CON-GRY

Thick Foam Padding and Plush Micro-Fleece Lining

Three-Point Interior Padding System

FEATURED MODEL
GT-JUMBO-BLK

Thick Rubber Tread



Transit Acoustic Guitar Bag; Light Grey
MODEL: GT-ACOUSTIC-GRY

Transit Acoustic Guitar Bag; Charcoal
MODEL: GT-ACOUSTIC-BLK

Transit Acoustic Guitar Bag; Tan
MODEL: GT-ACOUSTIC-TAN

Transit Bass Guitar Bag; Light Grey
MODEL: GT-BASS-GRY

Transit Bass Guitar Bag; Charcoal
MODEL: GT-BASS-BLK

Transit Bass Guitar Bag; Tan
MODEL: GT-BASS-TAN

Transit Electric Guitar Bag; Light Grey
MODEL: GT-ELECTRIC-GRY

Transit Electric Guitar Bag; Charcoal
MODEL: GT-ELECTRIC-BLK

Transit Electric Guitar Bag; Tan
MODEL: GT-ELECTRIC-TAN

Grey Transit Bag - Concert Ukulele
MODEL: GT-UKE-CON-GRY

Black Transit Bag - Concert Uke
MODEL: GT-UKE-CON-BLK

Tan Transit Bag - Concert Uke
MODEL: GT-UKE-CON-TAN

Grey Transit Bag - Soprano Ukulele
MODEL: GT-UKE-SOP-GRY

Black Transit Bag - Soprano Uke
MODEL: GT-UKE-SOP-BLK

Tan Transit Bag - Soprano Ukulele
MODEL: GT-UKE-SOP-TAN

Grey Transit Bag - Tenor Ukulele
MODEL: GT-UKE-TEN-GRY

Tan Transit Bag - Tenor Ukulele
MODEL: GT-UKE-TEN-TAN

Add-On Accessory Bag for Transit Series Bags
MODEL: GT-1407-GRY

Black Transit Bag For Jumbo Acoustic
MODEL: GT-JUMBO-BLK

24" x 12" x 4.5" Grey Transit Series Accessory Bag
MODEL: GT-2412-GRY

16" x 10" x 4.5" Grey Transit Series Accessory Bag
MODEL: GT-1610-GRY

Black Transit Bag For Reso, 00 & Classical Guitars
MODEL: GT-RESO0CLASS-BLK

4G SERIES

4G STYLE GIG BAG WITH ADJUSTABLE BACKPACK STRAPS

- GFLEX 20mm padding on all sides
- Patent pending pick-clip to hold "emergency" pick
- Padded backpack style straps
- Contour back padding for comfort
- Large exterior pocket
- Internal headstock and bridge reinforcement to prevent wear
- Dual compartment padded gig bag designed to fit one (1) acoustic and one (1) electric guitar (GB-4G-ACOUSELECT)

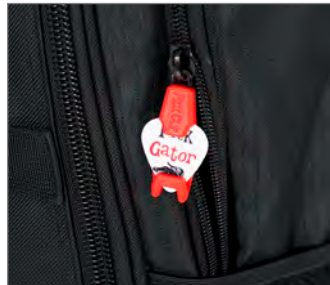

BUILT-IN PICK STORAGE



REINFORCED HANDLES

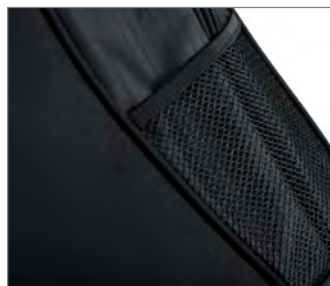

MESH POCKET STORAGE



FEATURED MODEL
GB-4G-ACOUSELECT

Dual Compartments

Padding on All Sides



FEATURED MODEL
GB-4G-ACOUSELECT

4G Series Gig Bag for Acoustic Guitars
MODEL: GB-4G-ACOUSTIC

4G Series Acoustic/Electric Double Gig Bag
MODEL: GB-4G-ACOUSELECT

4G Series Gig Bag for Mini Acoustic Guitars
MODEL: GB-4G-MINIACOU

4G Series Gig Bag for Classical Guitar
MODEL: GB-4G-CLASSIC

4G Series Gig Bag for Electric Guitars
MODEL: GB-4G-ELECTRIC

4G Series Gig Bag for 2 Electric Guitars
MODEL: GB-4G-ELECX2

4G Series Gig Bag for Bass Guitars
MODEL: GB-4G-BASS

4G Series Gig Bag for 2 Bass Guitars
MODEL: GB-4G-BASSX2

4G Series Gig Bag for Jazzmaster Guitar
MODEL: GB-4G-JMASTER

4G Series Gig Bag for Concert Ukulele
MODEL: GB-4G-UKE CON

4G Series Gig Bag for Soprano Ukulele
MODEL: GB-4G-UKE SOP

4G Series Gig Bag for Tenor Ukulele
MODEL: GB-4G-UKE TEN

GBE SERIES
LIGHTWEIGHT GIG BAGS



ADJUSTABLE NO-SLIP GRIP

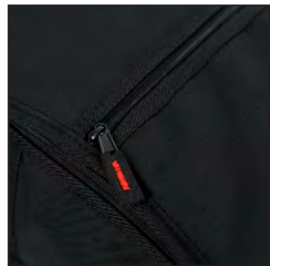

RUGGED, NYLON EXTERIOR



HEAVY-DUTY HANDLE



REMOVABLE STRAP

FEATURED MODEL
GBE-MINI-ELEC

- Rugged, 600-denier nylon exterior forms a durable, water-resistant outer shield
- Dense, 10mm foam core padding keeps your guitar safe from bumps and scratches
- Spacious exterior storage pocket keeps your favorite strings, picks and accessories organized
- Heavy-duty nylon carry handle gives you a firm grip
- Built-in backpack straps makes it comfortable and easy to take your bag on the road



FEATURED MODEL
GBE-CLASSIC

Acoustic Bass Guitar Gig Bag
MODEL: GBE-AC-BASS

Bass Guitar Gig Bag
MODEL: GBE-BASS

Classical Guitar Gig Bag
MODEL: GBE-CLASSIC

Dreadnought Guitar Gig Bag
MODEL: GBE-DREAD

Electric Guitar Gig Bag
MODEL: GBE-ELECT

Unique Shaped Guitar Gig Bag
MODEL: GBE-EXTREME-1

Jazzmaster Guitar Gig Bag
MODEL: GBE-JMASTER

Mini Acoustic Guitar Gig Bag
MODEL: GBE-MINI-ACOU

Mini Electric Guitar Gig Bag
MODEL: GBE-MINI-ELEC

Concert Ukulele Gig Bag
MODEL: GBE-UKE-CON

Soprano Ukulele Gig Bag
MODEL: GBE-UKE-SOP

Tenor Ukulele Gig Bag
MODEL: GBE-UKE-TEN

HANGING CLOSET BAGS

LIGHTWEIGHT GIG BAGS



- Provides extra storage for guitars by occupying unused closet space
- Dual closet rail hooks attached to reinforced nylon web straps safely hangs guitar inside bag
- Tough, grey polyester exterior keeps guitar from direct contact with closet items & provides dust protection
- Soft Tricot interior lining prevents scratches and surface damage
- Ventilation grommet ensures proper humidity during long-term storage
- Mesh pockets with hook-&-loop closures for storing tuner, strings, & other accessories
- Rear handle strap for easy retrieval

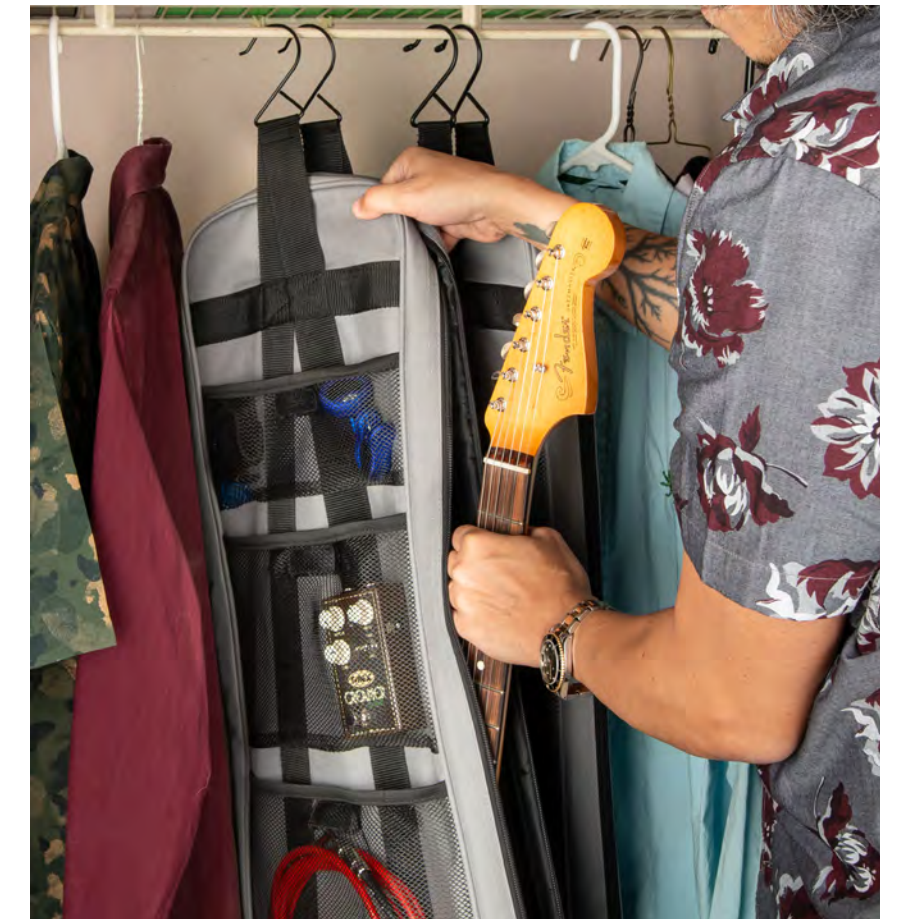



**Closet Hanging Bag
For Acoustic Guitars**
MODEL: GCB-ACOUSTIC
43"L x 16.5"W x 5"H



**Closet Hanging Bag
For Bass Guitars**
MODEL: GCB-BASS
47.5"L x 13.50"W x 2.75"H



**Closet Hanging Bag
For Electric Guitars**
MODEL: GCB-ELECTRIC
42"L x 13"W x 2.75"H



SOFT TRICOT INTERIOR



VENTILATION GROMMET



DUAL CLOSET RAIL HOOKS

ICON GUITAR STRAP

HEAVY DUTY HYPALON GUITAR STRAP

- Rubberized Military-Grade Hypalon Strap Ends with Reinforcement Rivets for Added Durability
- Lightweight & Comfortable Design: 3" (76mm)-Wide Breathable Neoprene Padding Helps Distribute Weight Evenly During Long Performances
- Anti-Tear, Water-Resistant 2.5" (64mm)-Wide Nylon Seatbelt Fabric
- Adjustable Length From 42 - 47" (1067 - 1194mm)
- Convenient Pick Holder for Quick & Easy Access
- Pinhole Stitching to Prevent Stretching

Icon Guitar Strap - Large
MODEL: G-ICON-3INSTRAP-BLKL

Icon Guitar Strap - Small
MODEL: G-ICON-3INSTRAP-BLKS



PIN HOLE STITCHING



TRI-GLIDE ADJUSTMENT

FRET MUTES

GATOR FRET MUTE STRING DAMPENERS

- Suppresses overtones and sympathetic resonance of open strings during various tapping techniques or general playing
- Dampens strings on fretboard or above nut on headstock of guitar
- Great for studio recordings, rehearsals and live performances
- Stretchy material with hook-and-loop strap to adjust the level of dampening
- Small and compact - store directly in gig bag pocket or guitar case accessory compartment



Fret Mute - Small
MODEL: GTR-FRETMUTESM-1BK
Fits 6-String Electric or Acoustic Guitars,
4-String Basses & Ukuleles



Fret Mute - Medium
MODEL: GTR-FRETMUTEMD-1BK
Fits 7-String Electric Guitars, 5-String Basses
& 6-String Classical Acoustic Guitars



Fret Mute - Large
MODEL: GTR-FRETMUTELG-1BK
Fits 8-String Electric Guitars
& 6-String Basses

Fret Mute - Extra Large
MODEL: GTR-FRETMUTEXL-1BK
Fits Oversized Neck Widths,
Including 7 to 10-String Basses
& Chapman Sticks

Fret Mute - 3-Pack - Medium
MODEL: GTR-FRETMUTEMD-3BK
Fits 7-String Electric Guitars, 5-String Basses
& 6-String Classical Acoustic Guitars

GUITAR FOOTREST

GUITAR FOOTREST WITH 5 HEIGHT SETTINGS

- ABS Construction with Soft, EVA and PU Foam Interior
- 5-Position Height Adjustment from 5" - 9.5" (12.7 - 24.1 cm)
- Conveniently Folds Flat for Ease of Storage in Your Guitar Case or Gig Bag
- Rubber Pad on Top Surface Provides Maximum Comfort While Playing
- Rubber Feet Prevent Slippage and Damage to Floor

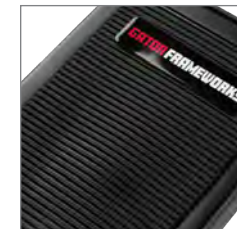

RUBBER PAD ON TOP SURFACE

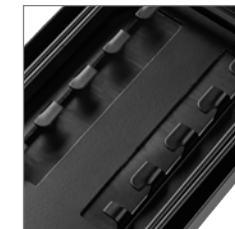

5-POSITION HEIGHT ADJUSTMENT



Guitar Footrest with 5 Height Settings
MODEL: GFW-GTR-FOOTREST

DESK CLAMPING GUITAR REST

TABLE & DESK CLAMPING GUITAR REST CRADLE



Desk Clamping Guitar Rest
MODEL: GFW-GTR-DSKCLAMP-1000

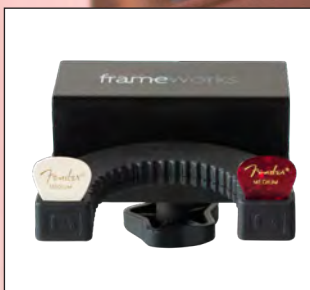

- Provides Safe Alternative to Temporarily Leaning Guitar Against Table or Desk Edge
- Keeps Electric or Acoustic Guitar in Close Reach when Stand is Far Away from Workstation
- 2.5"/64mm-Wide Rubberized Neck Cradle with Convenient Dual Pick Slots
- Securely Mounts to Any Table or Desktop Surface up to 1.7"/43mm in Thickness
- 5mm-Thick EVA Foam Padding Prevents Damage to Surface when Mounting
- Safe for Standard Polyurethane Finishes, Not Tested for Compatibility with Vintage/Lacquer Finishes

WALL MOUNT GUITAR & UKE HANGER

WALL MOUNTED GUITAR & UKULELE/MANDOLIN HANGER WITH MOUNTING PLATE



FEATURED MODEL
GFW-GTR-HNGRMPL

FEATURED MODEL
GFW-UKE-HNGRBLK



FEATURED MODEL
GFW-GTR-HNGRCHR



FEATURED MODEL
GFW-GTR-HNGRSCH



FEATURED MODEL
GFW-UKE-HNGRMHG

- Fits Electric Guitars, Acoustic Guitars, Bass Guitars and all sizes of Ukuleles and Mandolins
- Sleek Black Standoff Provides Clearance for Both Straight and Angled Headstocks
- Superior Mounting Design ensures the Instrument Hangs Parallel with the Wall for Flawless Display
- Black, Cherry, Mahogany, Maple or Chrome Decorative Wall Plate Hides Mounting Hardware for Clean and Stylish Look
- Foam Wall Pad Prevents Surface Scratches or Marring
- Includes Mounting Screws and Drywall Anchors
- Safe For Standard Polyurethane Finishes, Not Recommended For Vintage/Lacquer Finishes

Black Wall Mount Guitar Hanger
MODEL: GFW-GTR-HNGRBLK

Black Wall Mount Ukulele/Mandolin Hanger
MODEL: GFW-UKE-HNGRBLK

Cherry Wall Mount Guitar Hanger
MODEL: GFW-GTR-HNGRCHR

Cherry Wall Mount Ukulele/Mandolin Hanger
MODEL: GFW-UKE-HNGRCHR

Mahogany Wall Mount Guitar Hanger
MODEL: GFW-GTR-HNGRMHG

Mahogany Wall Mount Ukulele/Mandolin Hanger
MODEL: GFW-UKE-HNGRMHG

Maple Wall Mount Guitar Hanger
MODEL: GFW-GTR-HNGRMPL

Maple Wall Mount Ukulele/Mandolin Hanger
MODEL: GFW-UKE-HNGRMPL

Silver Wall Mount Guitar Hanger
MODEL: GFW-GTR-HNGRSCH

CLOSET HANGER YOKE

CLOSET HANGING YOKE FOR ACOUSTIC, ELECTRIC & BASS GUITARS



FEATURED MODEL
GFW-GTRCLOSETHNGR-DLX

- Provides Extra Storage for Guitars by Occupying Unused Closet Space
- Deluxe Version Yoke Swivels to Fit Different Style Headstocks
- Great for Dorms, Small Apartments, Studios, Luthier Workshops
- Features Rubberized Yoke with Soft Plastic End Caps to Prevent Scratches to Headstock & Neck
- Attaches to Rail Tubing 1.25"/32mm in Diameter & Fits Necks up to 2"/51mm Wide
- Heavy-Duty Steel Construction with Black Powder Coat Finish
- Safe for Standard Polyurethane Finishes, Not Recommended for Vintage/Lacquer Finishes

Deluxe Closet Hanger Yoke
MODEL: GFW-GTRCLOSETHNGR-DLX

Closet Hanger Yoke
MODEL: GFW-GTRCLOSETHNGR



FEATURED MODEL
GFW-GTRCLOSETHNGR



DELUXE VERSION YOKE SWIVEL

LOCKING YOKE GUITAR STAND

SINGLE HANGING GUITAR STAND WITH SELF-LOCKING YOKE



Locking Yoke Guitar Stand
MODEL: GFW-GTR-1500

- Rubberized Self-Locking Yoke Safely Fits Both Electric & Acoustic Guitars & Bases
- Convenient Cam Lock Allows for Quick & Easy Height Adjustments
- Padded Body Cradle with Position Adjustment Prevents Surface Scratching or Marring
- Collapsible Design for Easy Travel & Storage: Neck Yoke, Body Cradle & Tripod Legs Fold Down
- Safe for Standard Polyurethane Finishes, Not Tested for Compatibility with Vintage/Lacquer Finishes
- Rubber Non-Skid Feet Cups with Red Safety Rings Provide Extra Stability



SELF-LOCKING YOKE



EASY HEIGHT ADJUSTMENT

LOCKING YOKE GUITAR STAND

SINGLE HANGING GUITAR STAND WITH SELF-LOCKING YOKE



**Hanging Guitar Stand
with Locking Yoke**
MODEL: GFW-GTR-1700

- Rubberized Self-Locking Yoke Safely Fits Both Electric & Acoustic Guitars & Basses
- Hanging Design Easily Accommodates Offset and Non-Traditional Guitars
- Cam Lock Allows for Quick & Easy Height Adjustments
- Padded Locking/Retractable Leg Housing Prevents Surface Scratching or Marring
- Collapsible Design for Easy Travel & Storage
- Safe for Standard Polyurethane Finishes, Not Tested for Compatibility with Vintage/Lacquer Finishes
- Rubber Non-Skid Feet Cups with Red Safety Rings Provide Extra Stability
- Height Adjustable from 23.5" - 44.4" (596.9 - 1127.25 mm)



SELF-LOCKING YOKE

SINGLE GUITAR STAND - HANGING

HANGING STYLE SINGLE GUITAR STAND WITH FIXED YOKE

- Adjustable stand (35" - 40") fits one electric or one acoustic guitar
- Heavy-duty steel tubing construction is both lightweight and durable
- Durable neck restraint cradles the neck for a secure fit
- Rubberized padding protects your guitar's finish from scratches
- Matte black finish seamlessly blends into the background

Single Guitar Stand - Hanging

MODEL: GFW-GTR-1200



"A" STYLE GUITAR STAND

"A" STYLE GUITAR STAND WITH CONTOURED CRADLE

- Holds one electric, acoustic, and bass guitar
- Finish friendly rubberized cradle padding
- Adjustable width for smaller instruments
- Compact foldable design
- Heavy-duty steel construction

"A" Style Guitar Stand

MODEL: GFW-GTRA-4000



TRIPOD STYLE GUITAR STAND

TRIPOD STYLE GUITAR STAND WITH HEAVY DUTY TUBING & RUBBER PADDING

- Holds Acoustic or Electric Guitars
- Heavy-duty steel tubing construction is both lightweight and durable
- Durable neck restraint fastens around the neck for a secure fit
- Rubberized cradle padding maintains your guitar's finish in scratch-free
- Removable red safety trim on feet adds a touch of visibility
- Matte black finish seamlessly blends into the background



NECK RESTRAINTS



RED SAFETY TRIM



Single Guitar Stand
MODEL: GFW-GTR-1000



Double Guitar Stand
MODEL: GFW-GTR-2000



Triple Guitar Stand
MODEL: GFW-GTR-3000

ROK-IT A-FRAME GUITAR STAND

ROK-IT A-FRAME GUITAR STAND FOR ELECTRIC OR ACOUSTIC GUITARS

- "A Frame" Style Guitar Stand for Electric or Acoustic Guitars
- Locking arms for added security
- Compact, Collapsible Design Folds Flat for Easy Storage
- Steel Construction with Rubber Grip Feet
- Finish Friendly, Padded Guitar Stand Arms

Rok-It A-Frame Guitar Stand
MODEL: RI-GTRAU



Rok-It Double A-Frame Guitar Stand
MODEL: RI-GTRAU2X

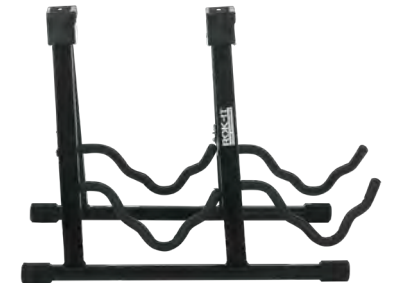

ROK-IT GUITAR STAND

"A" STYLE GUITAR STAND WITH CONTOURED CRADLE

- Black Powder Coated Finish
- Heavy Duty Metal Tube Construction
- Padded Neck and Body Cradles
- Rubber Feet
- Security Strap

Rok-It Guitar Stand
MODEL: RI-GTRSTD-1



SECURITY STRAP

ROK-IT GUITAR RACKS

ROK-IT COLLAPSIBLE 3, 5 & 7 SPACE GUITAR RACKS



FEATURED MODEL
RI-GTR-RACK10

- Holds Multiple Guitars or Basses: Perfect for electric or acoustic instruments, providing secure and organized storage for your collection.
- Protective Foam Padded Cradle: Prevents scratches and damage, ensuring your guitars stay in pristine condition.
- Heavy-Duty Steel Construction: Built to last with a powder-coated black finish for durability and a sleek appearance.
- Space-Saving Folding Design: Conveniently collapses for easy storage or transport, ideal for gigs, studios, and home use.
- Stable Rubber Feet: Keep the rack firmly planted on any surface, preventing slipping or wobbling.
- Finish-Friendly Design: Safe for standard polyurethane finishes; Note: not tested for vintage or lacquer finishes.

Rok-It Guitar Rack 3
MODEL: RI-GTR-RACK3

Rok-It Guitar Rack 5
MODEL: RI-GTR-RACK5

Rok-It Guitar Rack 7
MODEL: RI-GTR-RACK7

Rok-It Guitar Rack 10
MODEL: RI-GTR-RACK10



FEATURED MODEL
RI-GTR-RACK5

GUITAR RACK STANDS SERIES

RACK STYLE GUITAR STAND THAT FOLDS INTO CASE

- Stand holds 4 or 6 electric, acoustic, or bass guitars
- Stand section locks into place with recessed twist latches
- Elastic secure bands keep guitars from sliding out if stand is bumped
- Birch wood construction with grey carpeted exterior covering
- Plush lined interior
- Commercial grade, Penn-Elcom twist latches and hardware
- Comfortable carry handle
- Feet on bottom to prevent wear during uses



FEATURED MODEL
GTRSTD4

FEATURED MODEL
GTRSTD6

**Rack Style 4 Guitar Stand that
Folds into Case**
MODEL: GTRSTD4

**Rack Style 6 Guitar Stand
that Folds into Case**
MODEL: GTRSTD6



**COMMERCIAL GRADE
HARDWARE**



**COMFORTABLE CARRY
HANDLE**



**PADDLED LINED SLOTS WITH
ELASTIC SECURE BANDS**



**PLUSH STAND AREA WITH
END PIN GROOVE**

MOBILE UKULELE RACKS

TO HOLD UP TO 18 OR 30 UKULELES WITH LOCKING CASTERS

NEW!



- **SECURE INSTRUMENT PROTECTION:** Integrated yoke holders with EVA foam padding and rubber safety straps help guard ukuleles from scratches and movement while stored or transported.
- **COMPACT HIGH CAPACITY STORAGE:** Holds up to 18 or 30 ukuleles in a space-saving 2 tier design.
- **CLASSROOM READY MOBILITY:** Locking casters allow smooth rolling and stable positioning, making it easy to move the rack safely around classrooms or rehearsal spaces.
- **FURNITURE STYLE DESIGN:** Dark walnut laminate finish delivers a polished, professional appearance that blends seamlessly into music rooms or educational environments.

Mobile 18 Ukulele Rack
MODEL: GFW-EDU-UKERACK18

Mobile 30 Ukulele Rack
MODEL: GFW-EDU-UKERACK30



RUBBER SAFETY STRAPS



DELUXE GUITAR SEAT

DELUXE GUITAR SEAT WITH ADJUSTABLE BACK REST & GUITAR HANGER

- Convenient Neck Yoke on Rear Side Safely Holds Acoustic, Electric or Bass Guitar
- Features Height-Adjustable Seat, Backrest & Footrest
- Ergonomically Designed Seat Cushion with 3"/76mm-Thick Foam Padding for Maximum Comfort During Long Performances
- Soft Back Rest with 2.5"/64mm-Thick Foam Padding and 1.38"/35mm of Adjustable Travel
- Seat Height Adjusts from 20.75"/527mm to 32.5"/826mm
- Footrest Equipped with Non-Slip Grip Tape to Maintain Desired Playing Position
- Rubber Feet Keep You Firmly Planted on Stage
- Folds for Easy Transport & Storage
- 300 lb. weight capacity

Deluxe Guitar Seat
MODEL: GFW-GTR-SEATDLX



HEIGHT ADJUSTABLE BACKREST

GUITAR SEAT & STAND COMBO

COMBINATION GUITAR PERFORMANCE SEAT AND SINGLE GUITAR STAND

- 2.5"/64mm Thick Padded Seat Cushion
- Collapsible Design with Quick Release Pin for Compact Storage
- Removable, ergonomic backrest secures to seat bottom (Available for GFW-GTR-SEAT)
- Integrated Footrest for Comfortable Playing Position During Performances
- Soft Micro-Suede Patch on Seat for Resting Guitar Neck
- Rubber Feet with Red Safety Trim for Visibility in Dark Settings
- Some assembly required, hardware included
- Maximum Weight Capacity of 300 lbs./113.4 kg

Guitar Seat/Stand Combo
MODEL: GFW-GTR-SEAT

Guitar Stool with Stand
MODEL: GFW-GTRSTOOL



PADDED NECK CRADLE



FOLDABLE GUITAR STAND

VERTEX SERIES PEDALBOARDS

LIGHTWEIGHT ALUMINUM PEDALBOARDS WITH CARRYING BAGS

NEW!

Vertex Effects and Gator Cases have come together in an exclusive partnership to deliver one of the most versatile pedalboard ecosystems on the market. Where the creative innovation of Vertex meets the rugged, tour-tough engineering of Gator Cases, it's no wonder the Vertex By Gator pedalboard meets the needs of any player - bringing their effects, tone, and creativity to life.



- **DURABLE ALUMINUM FRAME:** Constructed from lightweight, rugged 8-gauge aluminum for long-term reliability while keeping weight to a minimum, ideal for frequent transport and gig use. Non-slip rubber feet provide maximum stability on stage, and smooth, rounded edges and corners allow for safer, more comfortable handling.
- **OPTIMIZED PEDALBOARD DESIGN:** Durable, non-textured powder coat allows a reliable hold after precise self-fastener placement, while large platform cutouts make cable routing and cable management easy. Magnetized flip-top 2nd tier for added layer of pedals and additional easy-access positioning slots for interchangeable modules
- **PREMIUM GIG BAG INCLUDED:** Weather-resistant 600D nylon gig bag with 20mm foam padding, YKK zippers, spacious pockets, padded contoured handle, 10' rolls of both hook and loop fastener, 12 4" cable ties, and D-rings for optional shoulder strap ensures secure, protective, and convenient transport.



FEATURED MODEL
GV-TC2313-GB



Vertex Tour Compact 23" x 13" Pedalboard w/ Bag
MODEL: GV-TC2313-GB

Vertex Tour Compact 23" x 13" Pedalboard & Riser w/ Bag
MODEL: GV-TC2313R2-GB

Vertex Travel Lite 17" x 10" Pedalboard w/ Bag
MODEL: GV-TL1710-GB

Vertex Travel Lite 17" x 10" Pedalboard & Riser w/ Bag
MODEL: GV-TL1710R1-GB

Vertex Tour Compact 27" x 13" Pedalboard w/ Bag
MODEL: GV-TC2713-GB

Vertex Tour Compact 27" x 13" Pedalboard & Riser w/ Bag
MODEL: GV-TC2713R2-GB

Vertex Tour Elite 31" x 13" Pedalboard w/ Bag
MODEL: GV-TE3113-GB

Vertex Tour Elite 31" x 13" Pedalboard & Riser w/ Bag
MODEL: GV-TE3113R2-GB

FEATURED MODEL
GV-TC2713R2-GB



Vertex Cable Tie and Cable Tie Holder 48-Pack
MODEL: GV-RDCTP-48

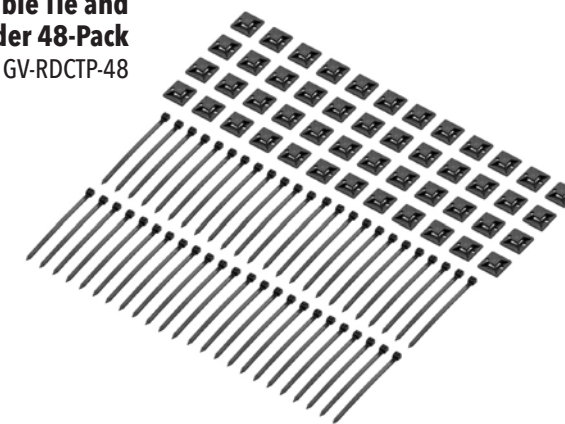

Vertex Pedalboard Mounting Kit
MODEL: GV-RDPBMK-4824

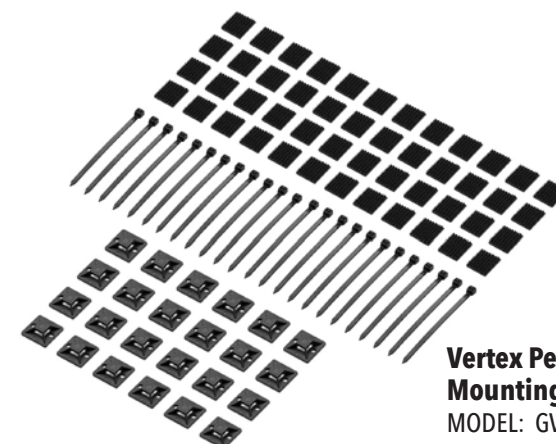

ALUMINUM SERIES

LIGHTWEIGHT ALUMINUM PEDAL BOARDS



CABLE PORT ALLOWS EASY ACCESS FOR POWER AND SIGNAL ROUTING

- Pedal surface measures 15.75" X 7" (small), 23.75" x 10.66" (large), 32" x 17" wide enough to accommodate up to 20 pedals (x-large)
- Universal mounting bracket provided for mounting most common power supplies beneath the board (X-Large models include 2 brackets)
- Intelligent design with gradual incline for optimum access to pedals
- Cable routing perforations make routing signal and power easy
- No-slip rubber feet keep the board stable
- Includes adhesive velcro strips (small & large)
- Heavy-duty, reinforced nylon carrying case with adjustable, removable shoulder strap and padded comfort-grip carry handle (x-large)
- Deluxe carry bag with polyethylene reinforced top and bottom has removable shoulder strap
- Large rear access holes for power cable routing
- Perfect for heavy gigging, pro-level musicians and larger boutique style pedals (x-large)



WHITE

White Aluminum Pedal Board; Large w/ Carry Bag
MODEL: GPB-BAK-WH

White Aluminum Pedal Board; Small w/ Carry Bag
MODEL: GPB-LAK-WH



SCREAMER GREEN

Green Aluminum Pedal Board; XL w/ Carry Bag
MODEL: GPB-XBAK-GR

Green Aluminum Pedal Board; Large w/ Carry Bag
MODEL: GPB-BAK-GR



BLACK

Black Aluminum Pedal Board; XL w/ Carry Bag
MODEL: GPB-XBAK-1

Black Aluminum Pedal Board; Large w/ Carry Bag
MODEL: GPB-BAK-1



BRITISH ORANGE

Orange Aluminum Pedal Board; XL w/ Carry Bag
MODEL: GPB-XBAK-OR

Orange Aluminum Pedal Board; Large w/ Carry Bag
MODEL: GPB-BAK-OR

Orange Aluminum Pedal Board; Small w/ Carry Bag
MODEL: GPB-LAK-OR

MOLDED CASES SERIES

HELIX FLOOR CASE WITH WHEELS

- Wheeled hard shell case for line 6 helix guitar multi-effects floor processor
- ATA molded polyethylene construction with soft, tricot-lined interior
- Removable hook-and-loop foam blocks (x2) and padded divider cradles board inside case
- Rubber wheels, telescoping pull handle & ergo-grip comfort handle for hassle-free transport
- Side storage compartment for power & USB cable
- Black valences and quick-release draw latches
- Side & bottom feet for added stability
- Exterior Dimensions: 27.25"/69.22 cm (L) x 14.00"/35.56 cm (W) x 7.00"/17.78 cm (H). Interior Dimensions: 23.50"/59.69 cm (L) x 12.00"/30.48 cm (W) x 4.75"/12.07 cm (H). Net Weight: 11.60 lbs. (5.26 kg)

Helix Floor Case
MODEL: GHELIXFLOOR



RUBBER WHEELS



REMOVABLE DIVIDER CRADLES



QUICK-RELEASE DRAW LATCHES

G-TOUR PEDAL BOARD SERIES

TOUR GRADE PEDAL BOARD AND FLIGHT CASES



FEATURED MODEL
G-TOUR PEDALBOARD-LGW



RETRACTABLE INLINE
WHEELS



RETRACTABLE
TOW-HANDLE

- Pro-grade shock absorbing EVA foam interior
- Removable pedal board surface
- Two (2) rubber-gripped handles for easy lifting in and out of the case
- 3M Dual Lock™ hook and loop fastener for pedal installation
- Cable and accessory storage under the removable pedal board
- Retractable tow-handle and inline wheels
- Plywood construction with aluminum edging to create a secure closure between lid and base
- Protective ball corners at vulnerable points
- Commercial grade Gator red signature hardware
- Lockable latches
- Spring-loaded rubber gripped handles



FEATURED MODEL
G-TOUR PEDALBOARD-SM



G-TOUR Pedal Board; Small
MODEL: G-TOUR PEDALBOARD-SM



G-TOUR Pedal Board; Large w/ Wheels
MODEL: G-TOUR PEDALBOARD-LGW



G-TOUR Pedal Board; Extra Large w/ Wheels
MODEL: G-TOUR PEDALBOARD-XLW

G-TOUR PEDAL BOARD SERIES

LINE 6 HELIX FLOOR TOUR CASE WITH WHEELS

- Wheeled ATA live-in tour case for Line 6 Helix guitar multi-effects floor processor
- Elevated platform for pedalboard allows unit to be used while remaining inside case
- Plywood construction with black laminated exterior
- Foam-padded lid protects top of board from damage during transport
- Rubber wheels & Gator signature red, spring-loaded grip handles for hassle-free transport
- Side storage compartment for power & USB cable
- Red recessed twist latches for easy lid removal
- Reinforced ball corners and side & bottom feet for Added Stability
- Tongue & groove extruded aluminum valance
- Exterior Dimensions: 30.25"/76.84 cm (L) x 15.25"/38.74 cm (W) x 8.50"/21.59 cm (H). Interior Dimensions: 28.25"/71.76 cm (L) x 13.25"/33.66 cm (W) x 5.50"/13.97 cm (H). Net Weight: 23.00 lbs./10.43 kg



RUBBER WHEELS



RECESSED TWIST LATCHES

Helix Floor Case with Wheels
MODEL: GTOURHELIXFLOOR

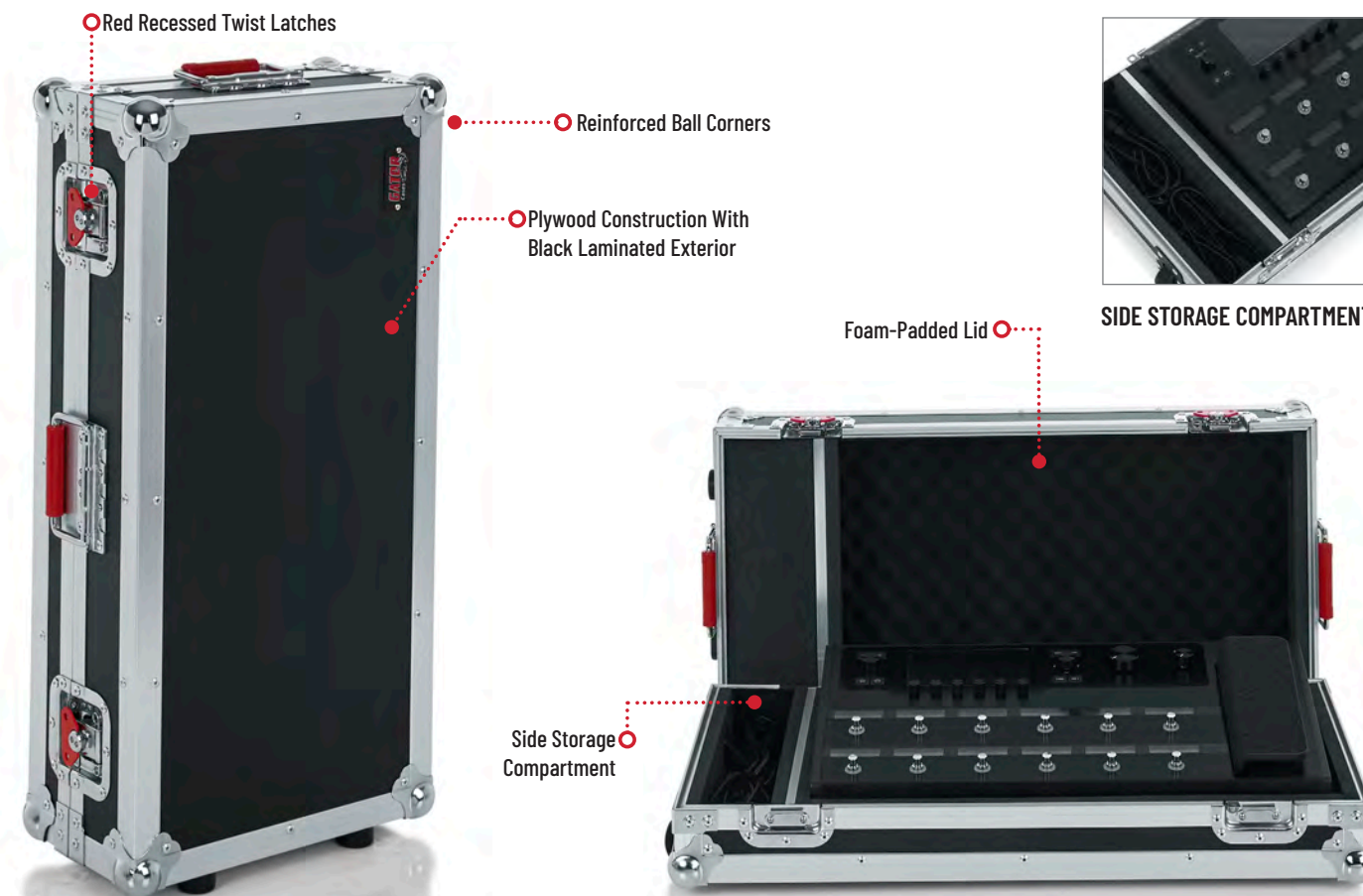

Red Recessed Twist Latches

Reinforced Ball Corners

Plywood Construction With Black Laminated Exterior

Foam-Padded Lid

SIDE STORAGE COMPARTMENT

Side Storage Compartment

GIG BOX SERIES PEDAL BOARD/GUITAR STAND CASE



ADJUSTABLE COLLAPSIBLE
STAND



RECESS IN PEDAL BOARD FOR
MOUNTING POWER SUPPLY



FEATURED MODEL
GW-GIGBOXJRPWR



G-Bus-8 Multi-Output 1700 Milliamp Power Supply

**Gig-Box Jr. Pedal Board/
Guitar Stand Case**
MODEL: GW-GIGBOXJR

**Gig-Box Jr. Pedal Board/Guitar
Stand Case w/ Power**
MODEL: GW-GIGBOXJRPWR

- Pedal Board and 3x Guitar Stand
- 21.25" x 15" (GW-GIGBOXJR) or 21.25" x 15" (GW-GIGBOXJRPWR) Pedal Board Surface
- Black Tolex Exterior
- Deluxe End Caps with White Stitching
- Black Plush Lined Stand Section
- Recessed Section on Pedal Board for Mounting Power Supply
- Lid Converts to Stand Holding 3x Electric Guitars or 2 Electric & 1 Acoustic Guitar
- Base Holds Pedals with Supplied Hook and Loop Fastener
- Carpet-Lined Interior
- Powered Version Comes with Gator's G-BUS-8 Multi-Output 1700 Milliamp Power Supply

BONE SERIES RIGID POLYETHYLENE PEDAL BOARD - ACCOMMODATES UP TO 3 OR 10 STOMP BOXES



FEATURED MODEL
G-MEGABONE



- USA made rigid polyethylene pedal board which accommodates up to 3 or 10 stomp boxes
- Ergo friendly arched shape
- 2 larger surfaces for Wah and volume type pedals
- Gator G-Bus-5 9v daisy chain power supply
- Hook and loop angled surface for pedal mounting
- Heavy-duty padded lightweight carry case



FEATURED MODEL
G-MEGABONE



**Mini Bone Pedal Board;
w/ Carry Bag**
MODEL: G-MINI BONE



**Bone Pedal Board; w/ Carry
Bag & Power Supply**
MODEL: G-BONE



**Mega Bone Pedal Board; w/
Carry Bag & Power Supply**
MODEL: G-MEGA-BONE

GUITAR PEDAL TOTES SERIES

PEDAL BOARD WITH CARRY BAG



FEATURED MODEL
GPT-PRO-PWR



STORAGE POCKETS FOR ACCESSORIES



POWER MOUNTS UNDER BOARD WITH CABLE ACCESS

- Plywood pedal board covered in tolex
- Pedal board comes with carry handle which slides into a rugged nylon padded carry case
- Pedal board has access holes for cables to run below board to utilize 4 supplied mounting screws for Gator G-BUS and similar size multi-output power supplies
- Exterior pocket for cables
- Face of pedal board covered with Velcro for attaching pedals - attachment Velcro included
- Powered version comes with Gator's G-BUS-8 multi-output power supply which can power up to 11 standard stomp boxes (GPT-BL-PWR, GPT-PRO-PW)
- Includes nine (9) 24" straight end cables to power pedals, (8) - 9v & (1) - 18v (GPT-BL-PWR, GPT-PRO-PWR)



FEATURED MODEL
GPT-BL-PWR



Pedal Board w/ Carry Bag
MODEL: GPT-BLACK

Pedal Board w/ Carry Bag; Pro Size
MODEL: GPT-PRO

Pedal Board w/ Carry Bag & Power Supply
MODEL: GPT-BL-PWR

Pedal Board w/ Carry Bag & Power Supply; Pro Size
MODEL: GPT-PRO-PWR

MULTI-FX SERIES

EFFECTS PEDAL BAG



FEATURED MODEL
G-MULTIFIX-2411

- Designed to accommodate most Multi-Effects Pedal Boards
- Durable nylon exterior
- 1/2" Protective padded interior
- Large accessory pocket for cables
- Adjustable shoulder strap
- Ergo grip carry handle



FEATURED MODEL
G-MULTIFIX-1110



11" x 10" Effects Pedal Bag
MODEL: G-MULTIFIX-1110



15" x 10" Effects Pedal Bag
MODEL: G-MULTIFIX-1510



24" x 11" Effects Pedal Bag
MODEL: G-MULTIFIX-2411

HOOK-AND-LOOP FASTENING TAPE

HOOK-AND-LOOP FASTENING TAPE FOR ATTACHING EFFECTS PEDALS TO PEDALBOARD

- 7-Foot roll of hook-and-loop fastening tape for attaching Effects Pedals to pedalboard
- Provides strong mounting solution to keep guitar Effects Pedals secured to board
- Includes married strip (both sides)
- Product Dimensions: 84"/2134mm (L) x 1"/25mm (W) x 0.25"/6mm (H)

1" Wide Strip of Hook & Loop Tape
MODEL: GTR-PWR-HOOKLP

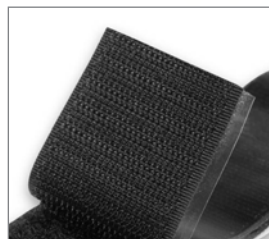

PRO LOCKING FASTENERS

PERFECT FOR ATTACHING PEDALS, DESKTOP SYNTHESIZERS, & OTHER MISC GEAR

Adheres Effortlessly to Aluminum, Stainless Steel, Acrylic, PC, ABS, Powder-Coated Finishes, and Polypropylene

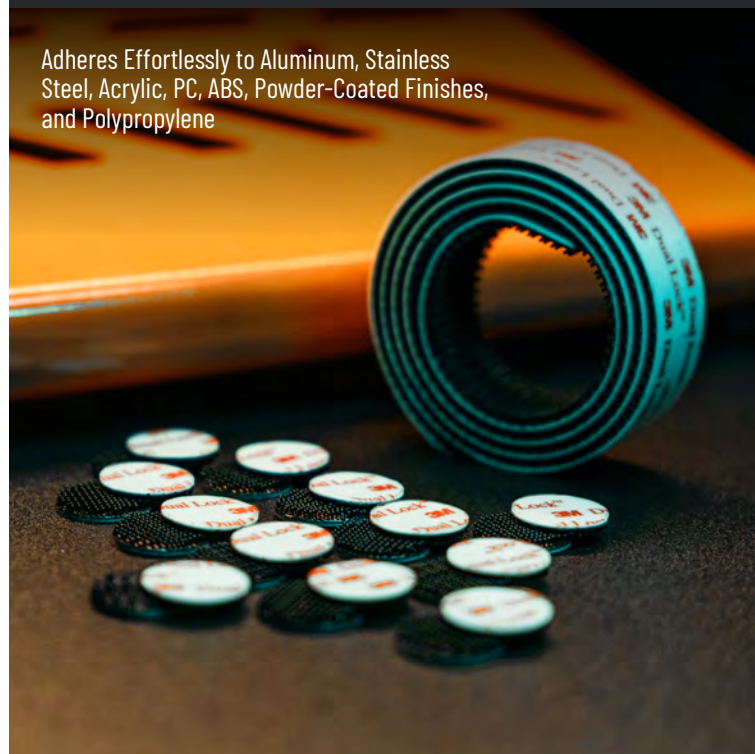

Pro Locking Fastener Tape; 1" x 36"

MODEL: G-LOCK-STRIP-136

- 1" x 36" strip of durable 3M Type 250 Dual Lock offers superior hold over traditional hook-and-loop solutions
- Strip can be cut to any length to suit your setup, offering flexible, reusable mounting options



Pro Locking Fastener Coins; 7/8" x 24 Pack

MODEL: G-LOCK-COIN-7824

- Includes 12 Pairs of 3M Dual Lock Coins for Secure Fastening
- Provides A Stronger, More Reliable Hold Compared to Traditional Hook-and-Loop Fasteners

METAL POCKET PEDALBOARD

DESIGNED TO FIT IN MOST GATOR CASES GIG BAGS



- 24 Gauge Metal Pedalboard
- Fits in Main Pocket of Most Gator Cases Gig Bags or Other Popular Brands
- Pedal Surface of 10.75in x 10.25in
- Holes for Cables Tie Use
- Holes for Power Cable Routing
- Works Great When Paired with the Gator Cases GTR-PWR-1MAX (sold separately)
- 2" Velcro included

Metal Pocket-Sized Pedalboard

MODEL: GPB-POCKETBOARD

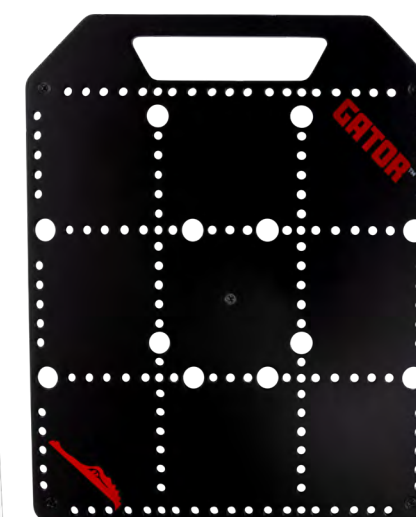

EFFECTS PEDAL POWER SERIES

GUITAR EFFECTS PEDAL POWER SUPPLY WITH 12 ISOLATED OUTPUTS - 2300MA



- Integrated Slots Allow for Direct Mounting to Pedal Board
- On/Off Power Switch with LED Indicator Light
- Heavy-Duty All Metal Enclosure with Slotted Vents for Heat Dissipation

Pedalboard Power Supply; 12 Outputs - max 2300mA

MODEL: GTR-PWR-12

- Outputs: 2 x 18V DC @ 120mA, 3 x 9/12V DC @ 120mA, 2 x 4-9V DC @ 120mA, 2 x 9V DC @ 300mA, 2 x 9V DC @ 500mA, 1 x USB @ 5V/2A (10W), 1 x AC Outlet
- AC Power Input with Switchable Voltage Between 115V/240V (50-60Hz) for International Use
- Voltage Adjustable on Outputs 3, 4 & 5 via DIP Switches
- Continuously Variable Voltage (4v ~ 9v) on Two (2) Outputs to Simulate Low Battery Effects
- AC Outlet on Rear Side

Pedalboard Power Supply; 8 Outputs - max 1600mA

MODEL: GTR-PWR-8

- Outputs: 2 x 4-9V DC @ 120mA, 3 x 9/12V @ 120mA, 1 x 9/18V DC @ 250mA, 1 x 9/12V DC @ 250mA, 1 x 12V AC @ 500mA
- AC power input with switchable voltage between 115V/240V (50-60Hz) for international use
- Voltage adjustable via DIP switch & SAG knobs (min 4V - max 9V)
- Includes (x1) Power Cable, (x8) DC Power Cables, (x1) AC Power Cable, (x1) Polarity Inverter Cable, (x1) Voltage Doubler Cable, (x1) Mini Jack Cable

Pedalboard Power Supply; 5 Outputs - max 600mA

MODEL: GTR-PWR-5

- Outputs: 5 x 9V DC @ 120mA
- AC power input with switchable voltage between 115V/240V (50-60Hz) for international use
- Great for smaller-size boards & setups
- Includes (x1) Power Cable, (x5) DC Power Cables & (x1) Polarity Inverter Cable



SLOTTED VENTS

AC POWER INPUT

EFFECTS PEDAL POWER SERIES

PEDALBOARD POWER SUPPLY; WALL WART COMBO PACK

- Cable Accessory Pack for Effects Pedal Power Supplies
- Contains Eight (8) Specialized Cables for Powering Pedals
- (x1) Current Doubler Adapter Cable, (x1) Voltage Doubler Adapter Cable, (x1) 5-Output Daisy Chain Cable, (x1) Polarity Inverter, (x1) 2.1mm to 3.5mm Adapter Cable, (x1) 9V Battery Adapter Cable, (x1) Standard 8" DC Power Cable, and (x1) 20" DC Power Cable



Pedalboard Power Supply; Wall Wart Combo Pack

MODEL: GTR-PWR-1MAX

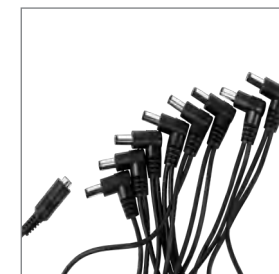
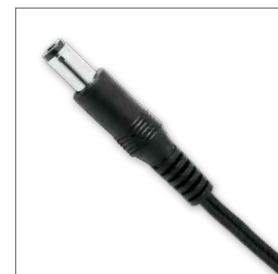

EFFECTS PEDAL POWER SERIES

PEDALBOARD POWER SUPPLY; WALL-WART 1700MA

- 9V DC Power Adapter for Guitar Effects Pedalboard
- Single output supplies maximum of 1700mA to power fully loaded pedalboard
- Slim design frees up space on power strip by occupying one outlet
- AC power input with variable voltage between 115V/230V (50-60Hz) for international use
- Works with optional female-to-male daisy chain adapter cable for connecting multiple pedals
- 8-Foot cable to reach far away outlets



Pedalboard Power Supply; Wall-Wart 1700Ma

MODEL: GTR-PWR-1

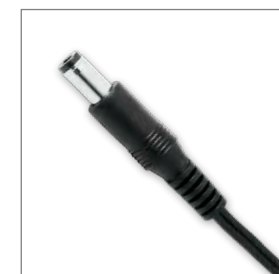

EFFECTS PEDAL POWER SERIES

CABLE ACCESSORY PACK FOR EFFECTS PEDAL POWER SUPPLIES

- Cable accessory pack for effects pedal power supplies
- Contains eight (8) specialized cables for powering pedals
- (x1) Current Doubler Adapter Cable, (x1) Voltage Doubler Adapter Cable, (x1) 5-Output Daisy Chain Cable, (x1) Polarity Inverter, (x1) 2.1mm to 3.5mm Adapter Cable, (x1) 9V Battery Adapter Cable, (x1) Standard 8" DC Power Cable, and (x1) 20" DC Power Cable

Pedal Power Cable Accessory Pack

MODEL: GTR-PWR-CABLEKIT



EFFECTS PEDAL POWER SERIES

FEMALE DAISY CHAIN POWER CABLE WITH 8 OUTPUTS

- 8-Output daisy chain power adapter cable with female input plug
- Connects up to eight (8) Effects Pedals from a single power output
- Attaches directly to male output plug on Gator GTR-PWR-1 or similar power adapter
- 1 x 2.5mm Female barrel input & 8 x 2.1mm right-angle male barrel outputs
- Convenient 12" cable distance between output plugs enables spacious pedal placement
- Overall Cable Length: 8'/2.4 m

Female Daisy Chain Power Cable With 8 Outputs

MODEL: GTR-PWR-DC8F



EFFECTS PEDAL POWER SERIES

FEMALE DAISY CHAIN POWER CABLE WITH 5 OUTPUTS

- 5-Output daisy chain power adapter cable with female input plug
- Connects up to five (5) Effects Pedals from a single power output
- Attaches directly to male output plug on Gator GTR-PWR-1 or similar power adapter
- 1 x 2.5mm Female barrel input & 5 x 2.1mm right-angle male barrel outputs
- Convenient 12" Cable distance between output plugs enables spacious pedal placement
- Overall Cable Length: 5'/1.5 m

Female Daisy Chain Power Cable With 5 Outputs

MODEL: GTR-PWR-DC5F



EFFECTS PEDAL POWER SERIES

MALE DAISY CHAIN POWER CABLE WITH 5 OUTPUTS

- 5-Output Daisy chain power adapter cable with male input plug
- Connects up to five (5) Effects Pedals from a Single power output
- Attaches directly to female output on Gator GTR-PWR-5, GTR-PWR-8, GTR-PWR-12 or similar power supply
- 1 x 2.5mm Male Barrel Input & 5 x 2.1mm Right-Angle Male Barrel Outputs
- Convenient 12" cable distance between output plugs enables spacious pedal placement
- Overall Cable Length: 5'/1.5 m

Male Daisy Chain Power Cable 4With 5 Outputs

MODEL: GTR-PWR-DC5M



EFFECTS PEDAL POWER SERIES

PEDAL POWER DC CABLE FOR EFFECTS PEDALS

- Pedal Power DC cable for Effects Pedals
- Connects one (1) pedal to one (1) output on power supply
- 1 x 2.1mm Right angle male plug and 1 x 2.1mm straight male plug
- Polarity: Center Negative (Standard)

20" Pedal Power DC Cable

MODEL: GTR-PWR-DCP20

32" Pedal Power DC Cable

MODEL: GTR-PWR-DCP32

40" Pedal Power DC Cable

MODEL: GTR-PWR-DCP40

8" Pedal Power DC Cable

MODEL: GTR-PWR-DCP8



EFFECTS PEDAL POWER SERIES

CURRENT DOUBLER CABLE FOR LINE 6 PEDALS

- Current doubler adapter cable for Line 6 HX Effects & HX stomp pedals
- Combines two (2) outputs on power supply into one (1) output & doubles the current rating
- 2 x 2.1mm Male right angle barrel plugs & 1 x 2.5mm straight male barrel plug
- Green color with black tip helps stand out from other cables
- Polarity: Center Negative (Standard)

Current Doubler Cable For Line 6 Pedals

MODEL: GTR-PWR-2XCURR-L6

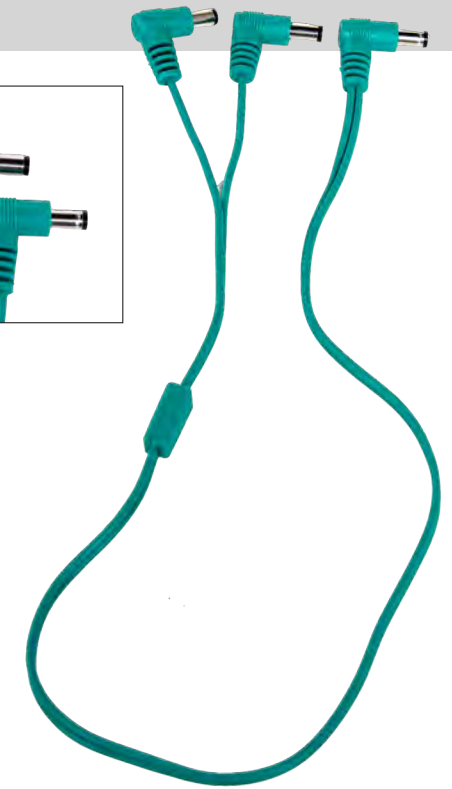

EFFECTS PEDAL POWER SERIES

POWER SUPPLY CURRENT DOUBLER CABLE SUPPLIES

- Current doubler adapter cable for Effects Pedal Power supplies
- Combines two (2) outputs on power supply into one (1) output & doubles the current rating
- 2 x 2.1mm Male right angle barrel plugs & 1 x 2.1mm straight male barrel plug
- Green color helps stand out from other cables
- Polarity: Center Negative (Standard)



Power Supply Current Doubler Cable

MODEL: GTR-PWR-2XCURRENT

EFFECTS PEDAL POWER SERIES

POWER SUPPLY VOLTAGE DOUBLER CABLE

- Voltage doubler adapter cable for Effects Pedal Power supplies
- Combines two (2) outputs on power supply into one (1) output & doubles the voltage rating
- 2 x 2.1mm Male right angle barrel plugs & 1 x 2.1mm straight male barrel plug
- Yellow color helps stand out from other cables
- Polarity: Center Negative (Standard)

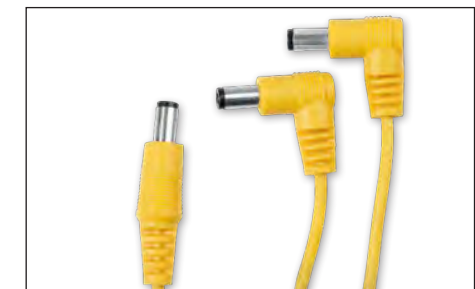

Power Supply Voltage Doubler Cable

MODEL: GTR-PWR-2XVOLTAGE

EFFECTS PEDAL POWER SERIES

POWER SUPPLY POLARITY INVERTER CABLE

- Polarity inverter cable for Effects Pedal Power supplies
- Allows for powering pedals with center positive (reverse) polarity
- 1 x 2.1mm Male right angle barrel plugs & 1 x 2.1mm straight female barrel plug
- Orange color helps stand out from other cables



Power Supply Polarity Inverter Cable
MODEL: GTR-PWR-POLARITY

G-BUS SERIES

PEDAL BOARD POWER SUPPLY

- Multi-output power supply for Guitar Effects Pedals
- Built-in short circuit protection with reset
- Heavy-duty aluminum housing
- 4 Holes for mounting to any pedal board
- Brass cylinders within mounting holes protect circuitry
- Eight (8) 9v outputs and three (3) 18v outputs
- Can power up to 11 standard Stomp box pedals
- Includes eight (8) 9 volt 24" straight end cables
- Includes one (1) 18 volt 24" straight end cable



Pedal Board Power Supply
MODEL: G-BUS-8-US

G-TOUR SERIES - AMP CASES

ATA TOUR CASE FOR AMP HEAD



FEATURED MODEL
G-TOUR HEAD

- Fits most popular guitar amplifier heads like the Marshall JCM Series
- "Lift off lid" design
- 3/8 Inch plywood construction
- Heavy-duty hardware



ATA Tour Case for Amp Head
MODEL: G-TOUR HEAD



PLYWOOD CONSTRUCTION



SPRING-LOADED RUBBER-GRIPPED HANDLE



RECESSED LOCKABLE TWIST-LATCHES



REINFORCED PROTECTIVE BALL CORNERS

G-TOUR MINI SERIES

ATA TOUR CASE FOR MID & LARGE SIZE 'LUNCHBOX' AMPS

- Heavy-duty plywood construction with laminated exterior
- Adjustable interior to fit medium sized "mini" guitar heads like the Marshall "JTM1H"[®]
- EVA ultra-durable foam interior protection
- Commercial grade, Gator red signature hardware
- Lockable twist latches for added security
- Spring-loaded rubber gripped handles
- Protective ball corners
- Rubber stabilizing feet

**FEATURED MODEL**
G-TOUR MINIHEAD 2/3**ATA Flight Case for Mid Size
'Lunchbox' Amps**

MODEL: G-TOURMINIHEAD2

**ATA Flight Case for Large
'Lunchbox' Amps**

MODEL: G-TOURMINIHEAD3

G-TOUR MINI SERIES

ATA TOUR CASE FOR 412 GUITAR SPEAKER CABINETS

- Adjustable fit case for most 4x12 size guitar speaker cabinets like the Marshall 1960 Series
- 3/8 Inch plywood construction
- Ultra-Dur EVA interior padding
- Front lid "stay in case" design with hinged rear access
- Rear cable port
- Heavy-Duty hardware
- 4 casters

**ATA Flight Case for 412 Guitar
Speaker Cabinets**

MODEL: G-TOUR CAB412

G-TOUR MINI SERIES

ATA TOUR CASE FOR 112 & 212 COMBO AMPS

- Adjustable fit case for most 1 x 12 size guitar Amps (G-TOUR AMP112) or 2 x 12 size guitar Amps (G-TOUR AMP212)
- 3/8 Inch plywood construction
- Heavy-duty interlocking interior padding
- Heavy-duty hardware
- "Lift off lid" design
- 4 Casters

**FEATURED MODEL**
G-TOUR AMP112**ATA Flight Case for 112 Combo Amps**

MODEL: G-TOUR AMP112

ATA Flight Case for 212 Combo Amps

MODEL: G-TOUR AMP212

ROTO MOLDED AMP SERIES

COMBO AMP TRANSPORTER / STAND; MOLDED PLASTIC

- Amp case fits most popular combo Amp sizes
- Indestructible Roto mold design
- Amp sits securely on top of case during use
- Open top design provides access to handle for easy transport
- Two wrap around straps with clips to secure lid to base during transport
- Frame height expands 16" to 21"
- Heavy-duty 2.5" swivel casters (2 locking)
- Made in the USA

**1X12 Combo Amp Transporter /
Stand; Molded Plastic**

MODEL: G-112-ROTO

**2X12 Combo Amp Transporter /
Stand; Molded Plastic**

MODEL: G-212-ROTO

**FEATURED MODEL**
G-212-ROTO

LIGHTWEIGHT AMP SERIES

WOODEN CASE W/ WHEELS & TOW HANDLE FOR AMP HEADS

- Ballistic nylon exterior over wood frame
- Interior is 20mm foam covered in Tricot
- Storage pocket for pedal controllers and channel switching pedals
- Web side carry handles
- Tow handle & wheels

Amp Head Case; Wooden Frame

MODEL: G-901



LIGHTWEIGHT AMP SERIES

WOODEN CASE & STAND W/ WHEELS & TOW HANDLE FOR COMBO AMPS

- Reinforced hard top for supporting amplifier on stage
- Rails to prevent amp from vibrating off the stage during performance
- Rugged nylon material over 1/2" wood frame
- Interior is 20mm foam covered in Tricot
- Tow handle & wheels
- External accessory pocket
- Max Load Weight: 60lbs (G-112A)
- Max Load Weight: 45lbs (G-212A)

1X12 Combo Amp Transporter / Stand; Wood Frame

MODEL: G-112A

2X12 Combo Amp Transporter / Stand; Wood Frame

MODEL: G-212A



FEATURED MODEL
G-112A

FEATURED MODEL
G-212A

LIGHTWEIGHT AMP SERIES

TRANSIT STYLE BAG FOR KEMPER PROFILING AMPS



- Transit series bag for Kemper Profiler Amp head, profiler remote & expression pedal
- Rugged, weather-resistant heathered fabric exterior with softly lined, rigid foam interior
- Reinforced front wall ensures protection of front knobs & menu screen
- Removable foam divider allows profiler head & remote to sit inside bag without contact
- Front zipper compartment for storing expression pedal
- Dual exterior side pockets & mesh interior lid pocket for storing power supply and cables
- 10mm padded shoulder strap & 5mm reinforced comfort handle
- Black rubber bar feet on bottom of the bag prevents wear and protects from small puddles to spilled drinks
- Orientation tag on front wall to indicate proper position of unit

Transit Style Bag For Kemper Profiler Amps

MODEL: GT-KEMPER-PRPH



RUBBER BAR FEET



REMOVABLE SHOULDER STRAP



DUAL EXTERIOR SIDE POCKETS



FOAM INTERIOR

LIGHTWEIGHT AMP SERIES

TITAN SERIES CASE WITH CUSTOM FOAM INSERT FOR THE UNIVERSAL AUDIO OX

- Transit Series bag for Universal Audio OX Amp Top Box Attenuator
- Rugged, weather-resistant heathered fabric exterior with softly lined, rigid foam interior
- Reinforced lid to protect knobs from bumps
- 1.63"/4.14 cm-thick removable foam insert with cutouts for rear knob & switch
- Front & back pockets for power supply & cables
- 5mm Padded shoulder strap & reinforced comfort handle
- Black rubber bar feet on bottom of the bag prevents wear and protects from small puddles to spilled drinks



Transit Style Bag for Universal OX
MODEL: GT-UNIVERSALOX

TITAN - AMP SERIES

TITAN SERIES CASE WITH CUSTOM FOAM INSERT FOR THE UNIVERSAL AUDIO OX

- Carry case for Universal Audio OX
- Water and dust proof with IP 67 Certification
- ATA-300 Certification
- Impact proof Lightweight NK-7™ Resin
- Easy release Powerclaw™ Latching System
- Soft grip comfort handle
- Pad-lockable
- Mil-STD-810F Immersion Test Certified



Titan Case for Universal Audio OX
MODEL: GU-UNIVERSALOX

COMBO AMP STAND

ELEVATED TILT-BACK COMBO AMP STAND

- Elevated Tilt-Back Amp Stand
- Angles Amp Up Towards User for Improved Listening & Easier Access to Controls
- Reduces Sound Transfer into Floor by Lifting Amp from Ground
- Top Frame Rotates & Locks to Desired Angle
- Works Great with both Combo Amps & Full-Size Amp Heads
- Adjustable Base for Controlling Height & Increased Stability
- Rubberized Feet & End Caps
- Collapses for Easy Travel
- Max Weight: 50 lbs
- Min/Max Height: 23/30" (584/762mm)



Combo Amp Stand
MODEL: GFWGTRAMP200



HEIGHT ADJUSTABLE

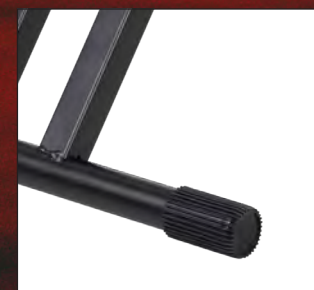

RUBBERIZED FEET

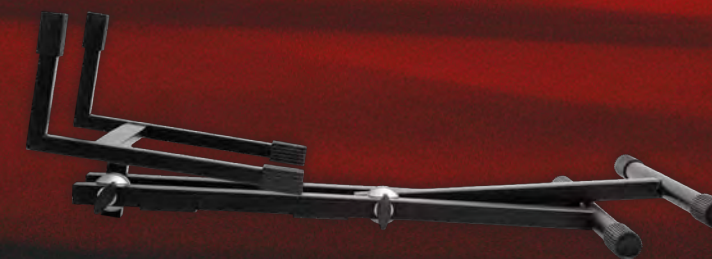

COMBO AMP STAND

COLLAPSIBLE TILT-BACK COMBO AMP STAND

- Collapsible Tilt-Back Combo Amp Stand
- Angles Amp Up Towards User for Improved Listening & Easier Access to Controls
- Folds Completely Flat into Compact Size for Easy Transport
- Reduces Sound Transfer into Floor by Lifting Amp from Ground
- Fixed Height & Position
- Rubberized Leveling Feet
- Heavy-Duty Construction
- Max Weight Capacity: 50 lbs/22.7kg

Combo Amp Stand
MODEL: GFWGTRAMP100



COMBO AMP STAND

COMBO AMP STAND WITH RUBBERIZED LEVELING FEET

- Tilt Back Design Accommodates Most Combo Guitar Amps
- Rubberized Leveling Foot
- Heavy Duty Steel Construction With Easy Adjustability
- 176Lb Weight Capacity (80 kg)
- Min/ Max Height: 5/20 Inches
(127/508 mm)
- Locks In Closed Position To Easily Carry

Combo Amp Stand
MODEL: GFW-GTR-AMP

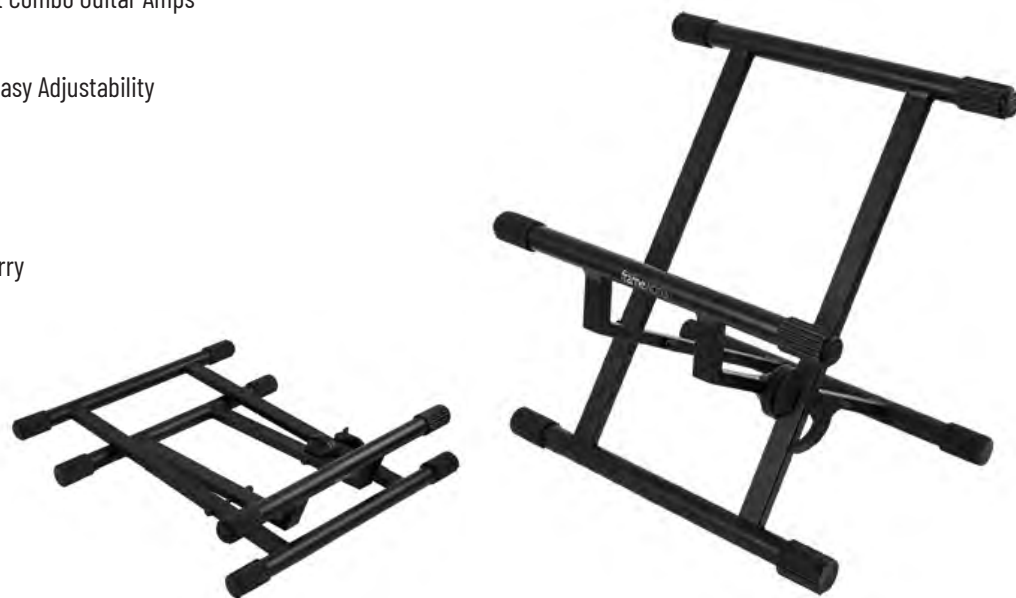

AMP STAND WITH BOOM ARM

AMP STAND WITH 5-POSITION TILT AND ADJUSTABLE BOOM ARM



- Safely Holds Amps Weighing Up to 100 lb (45.4 kg)
- 5 Leg Tilt Positions Provide Versatility in Amp Angle Adjustments
- Included Mic Boom Arm Provides an All-In-One Solution for Amp Miking
- EVA Foam On All Contact Surfaces Protect Your Amp While Preventing Unwanted Vibration
- Stand Folds to Compact Size for Ease of Transport and Storage

Amp Stand with Boom Arm
MODEL: GFW-GTR-AMP-BOOM



KEYBOARD

Let's face it, lugging around a keyboard is difficult. We've got cases and bags to fit your keyboard or digital workstation that will keep them safe from impacts along the way. Wheels, backpack straps, shoulder straps, you name it. However you prefer to get around, we've got your back.



2-TIER KEYBOARD
STAND IN RED
PAGE 118

CASES.....**106**
BAGS.....**109**
STANDS.....**116**

BENCHES.....**127**

FREQUENT FLYER TSA SERIES

TSA SERIES ATA MOLDED POLYETHYLENE KEYBOARD CASES



FEATURED MODEL
G TSA-KEY61



FEATURED MODEL
G TSA-KEY76

- Nearly indestructible polyethylene construction
- Two TSA accepted locking latches ideal for air travel
- Unique wedge and block design for interior customization
- 200lb Recessed in-line wheel weight capacity (for cases with wheels)
- Ergo-grip comfort handle and spring loaded rubber grip tow handle with 130lb weight capacity
- Surface mounted impact diversion latch housing & red release trigger
- Black powder coated hardware and continuous valance

49
NOTE
TSA ATA Molded 49-Note
Keyboard Case
MODEL: G TSA-KEY49

61
NOTE
TSA ATA Molded 61-Note
Keyboard Case w/ Wheels
MODEL: G TSA-KEY61



TSA APPROVED
LOCKING LATCHES



ERGO-GRIP
COMFORT HANDLE

76
NOTE
TSA ATA Molded 76-Note
Keyboard Case w/ Wheels
MODEL: G TSA-KEY76

76
NOTE
TSA ATA Deep 76-Note
Keyboard Case w/ Wheels
MODEL: G TSA-KEY76D



RECESSED
IN-LINE WHEELS



IMPACT DIVERTING
LATCH HOUSING

88
NOTE
TSA ATA Molded 88-Note
Keyboard Case w/ Wheels
MODEL: G TSA-KEY88

88
NOTE
TSA ATA Deep 88-Note
Keyboard Case w/ Wheels
MODEL: G TSA-KEY88D

88
NOTE
TSA ATA Slim 88-Note
Keyboard Case w/ Wheels
MODEL: G TSA-KEY88SL

88
NOTE
TSA ATA Slim XL 88-Note
Keyboard Case w/ Wheels
MODEL: G TSA-KEY88SLXL



FEATURED MODEL
G TSA-KEY49

X-STAND ADD ON BAG

FOR GATOR G-TOUR, TSA & GK SERIES WHEELED KEYBOARD CASES

- Add-on keyboard X-Stand Bag for Gator G-TOUR, G TSA & GK wheeled keyboard cases
- Top strap loops over pull handle of keyboard case for all-in-one transport solution
- Keeps keyboard and X-Stand together during transit
- Fits most foldable keyboard stands with max dimensions of 39.38"/1000mm (L) x 20.38"/518mm (W) x 3.75"/95mm (H)
- Doubles as carry bag with side handles & stowaway pocket for top strap when using in carry mode
- Tough polyester exterior with zipper compartment for storing additional accessories
- Product Dimensions: 39.38"/1000mm (L) x 20.38"/518mm (W) x 3.759"/95mm (H). Net Weight: 2.5 lbs./1.1 kg

X-Stand Add-On Bag For G-Tour, Gtsakey & Gk Cases
MODEL: GKBXSTANDBAG



G-TOUR KEYBOARD SERIES

ATA WOOD FLIGHT CASE FOR KEYBOARDS



FEATURED MODEL
G-TOUR-88V2XL

- Heavy-duty plywood construction with laminated exterior
- Tongue and groove extrusion aluminum valance
- Unique wedge and block design for interior customizing
- EVA Dur interior protection

- Reinforced ball corners
- Adjustable foam pads in lid
- Recessed wheels and spring-loaded rubber-gripped handles
- Heavy-duty commercial grade plated hardware



RECESSED WHEELS
(ON SELECT MODELS)



PROTECTIVE BALL CORNERS



61 Note Road Case w/ Wheels
MODEL: G-TOUR 61V2



76 Note Road Case w/ Wheels
MODEL: G-TOUR 76V2



88 Note Road Case w/ Wheels
MODEL: G-TOUR 88V2



Slim 88 Note Road Case w/ Wheels
MODEL: G-TOUR-88V2SL



Extra Large 88 Note Road Case w/ Wheels
MODEL: G-TOUR-88V2XL

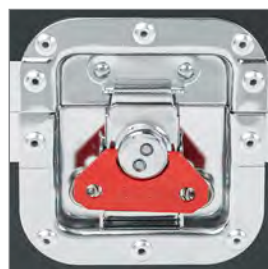

RECESSED TWIST LATCHES



RUBBER-GRIPPED SPRING-LOADED HANDLES

PRO GO SERIES

PRO-GO ULTIMATE GIG BAG FOR KEYBOARDS



FEATURED MODEL
G-PG-61SLIM

FEATURED MODEL
G-PG-61



- Ballistic nylon provides a rugged yet stylish outer shell
- Ultra-thick padded sidewalls protect against impact
- Ultra-soft micro fleece interior lining
- Padded interior strap with hook and loop enclosure snugly secures your instrument in place
- Extra-large front pocket with storage compartments keeps your cables, foot pedal, tablet, and other accessories organized

- Built-in protective rain cover fits snugly around the bag and protects against moisture
- Rain cover stores away conveniently into the exterior pocket
- Multi-adjustable, removable backpack straps offer multiple carrying options and added versatility
- Reinforced side haul handle provides a sturdy grip



Pro-Go Ultimate Gig Bag for 49-Note Keyboards
MODEL: G-PG-49



Pro-Go Ultimate Gig Bag for 61-Note Keyboards
MODEL: G-PG-61



Pro-Go Ultimate Gig Bag for Slim 61-Note Keyboards
MODEL: G-PG-61SLIM



Pro-Go Ultimate Gig Bag for 76-Note Keyboards
MODEL: G-PG-76



Pro-Go Ultimate Gig Bag for Slim 76-Note Keyboards
MODEL: G-PG-76SLIM



Pro-Go Ultimate Gig Bag for 88-Note Keyboards
MODEL: G-PG-88



Pro-Go Ultimate Gig Bag for Slim 88-Note Keyboards
MODEL: G-PG-88SLIM



Pro-Go Ultimate Gig Bag for Slim XL 88 Keyboards
MODEL: G-PG-88SLIMXL

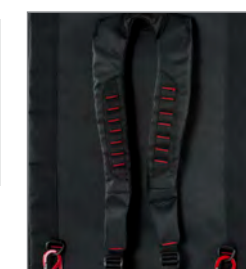

ADJUSTABLE, REMOVABLE BACKPACK STRAPS



PROTECTIVE RAIN COVER



TABLET STORAGE



SECURE INTERNAL STRAP SYSTEM

TRANSIT KEYBOARD GIG BAGS SERIES

TRANSIT SERIES PROTECTIVE GIG BAG FOR 61-NOTE & 61-NOTE SLIM KEYBOARDS



FEATURED MODEL
GTK61-BLK

- Weather-resistant polyester fabric exterior in black
- Soft micro fleece interior lining with 20mm-thick foam padding for case-like protection
- Adjustable hook-and-loop secure straps to hold keyboard in place during transport
- Convenient storage straps on exterior keep keyboard and "X" Style stand together during transit
- Padded stowaway backpack straps & removable shoulder strap
- Reinforced carry handles for easy loading & unloading
- Extra-large front pocket with multiple compartments for storing accessories
- Thick rubber tread & feet on bottom of bag prevents wear and protects against the elements



ADJUSTABLE PADDED
SECURE STRAPS



LARGE EXTERIOR
ACCESSORY POCKET



EXTERIOR
X-STAND STRAPS

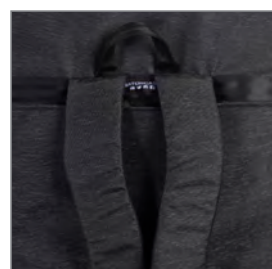

PADDED STOWAWAY
BACKPACK STRAPS

61
NOTE
Transit Keyboard Bag
For 61-Note Keyboards
MODEL: GTK61-BLK

61
NOTE
Transit Keyboard Bag For
61-Note Slim Keyboards
MODEL: GTK61SL-BLK

LEGACY HYBRID SERIES

RIGID EPS FOAM LIGHTWEIGHT CASE FOR KEYBOARDS



Rugged Nylon Construction

Large Accessory
Compartments

Tricot & Soft Foam Liner

Built-In Wheels

FEATURED MODEL
GK-49

- Rugged nylon construction with polyethylene reinforced interior frame
- Interior is lined with tricot & soft foam
- Fully adjustable padded straps to secure keyboard in place during transport
- Large accessory compartments on outside for pedals & cables
- Built-in wheels with tow handle & skid bars
- Adjustable foam pads in lid
- Recessed wheels and spring-loaded rubber-gripped handles
- Heavy-duty commercial grade plated hardware



BUILT-IN WHEELS & TOW-HANDLE



ADJUSTABLE PADDED INTERNAL STRAPS

49
NOTE
49 Note Lightweight
Keyboard Case
MODEL: GK-49

61
NOTE
61 Note Lightweight
Keyboard Case
MODEL: GK-61

61
NOTE
Slim 61 Note Lightweight
Keyboard Case
MODEL: GK-61-SLIM

76
NOTE
76 Note Lightweight
Keyboard Case
MODEL: GK-76

76
NOTE
Slim 76 Note Lightweight
Keyboard Case
MODEL: GK-76-SLIM

88
NOTE
88 Note Lightweight
Keyboard Case
MODEL: GK-88

88
NOTE
Slim 88 Note Lightweight
Keyboard Case
MODEL: GK-88 SLIM

88
NOTE
Slim, Extra Long 88 Note
Lightweight Keyboard Case
MODEL: GK-88 SLXL

88
NOTE
Extra Long 88 Note Light-
weight Keyboard Case
MODEL: GK-88 XL

LEGACY HYBRID SERIES

GIG BAG FOR MICRO KEYBOARDS AND CONTROLLERS

- Gig bag for midi controllers, production samplers or guitar effects pedals
- Heavy-duty rugged nylon construction
- Padded, soft-lined interior
- Comfortable, adjustable shoulder strap
- Large exterior accessory pocket perfect for cables and connectors



FEATURED MODEL
GK-2110

Micro Key/Controller Bag;
16"x10"x3"
MODEL: GK-1610

Micro Key/Controller Bag;
22.5"x11.5"x4"
MODEL: GK-2110

LEGACY HYBRID SERIES

MIDI CONTROLLER AND LAPTOP BACKPACK

- Rolling backpack designed to carry most 25-Note controllers and laptops
- Exterior storage for interfaces, cables, and other accessories
- Removable, retractable wheels and handle
- Expandable top accommodates up to 37-Note controllers
- Rugged nylon construction
- Padded interior and inserts protect gear
- Backpack straps can be hidden inside exterior pocket when handle is in use



25
NOTE
Midi Controller and Laptop Backpack
MODEL: GK-LT25W

MIZONE SERIES

KEYBOARD GIG BAGS



FEATURED MODEL
GKB-61

- Heavy-duty rugged nylon construction
- Adjustable padded secure straps to hold keyboard in place during transport
- Exterior accessory pocket
- Reinforced comfort riveted carry handles

49
NOTE
49 Note Keyboard Gig Bag
MODEL: GKB-49

61
NOTE
61 Note Keyboard Gig Bag
MODEL: GKB-61

61
NOTE
Slim 61 Note Keyboard Gig Bag
MODEL: GKB-61 SLIM

76
NOTE
76 Note Keyboard Gig Bag
MODEL: GKB-76

76
NOTE
Slim 76 Note Keyboard Gig Bag
MODEL: GKB-76 SLIM

88
NOTE
88 Note Keyboard Gig Bag
MODEL: GKB-88

88
NOTE
Slim 88 Note Keyboard Gig Bag
MODEL: GKB-88 SLIM

88
NOTE
Slim, Extra Long 88 Note Keyboard Gig Bag
MODEL: GKB-88 SLXL

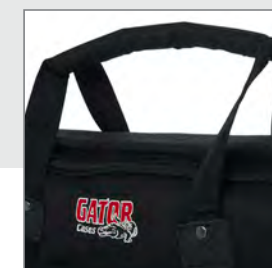

REINFORCED COMFORTABLE CARRY HANDLES



ADJUSTABLE PADDED SECURE STRAPS



LARGE EXTERIOR ACCESSORY POCKET



HEAVY-DUTY RUGGED NYLON CONSTRUCTION

CADET SERIES
LIGHTWEIGHT KEYBOARD BAGS



- Rugged Nylon gig bag fits 49-, 61-, 76- or 88-note keyboards
- 10mm Padding
- Simple envelope-style bag for entry level portable keyboards
- Nylon web handles



FEATURED MODEL
GKBE-49



49 Note Keyboard Gig Bag
MODEL: GBKE-49



61 Note Keyboard Gig Bag
MODEL: GBKE-61



76 Note Keyboard Gig Bag
MODEL: GBKE-76



88 Note Keyboard Gig Bag
MODEL: GBKE-88

KEYBOARD COVERS
STRETCHY COVERS



FEATURED MODEL
GKC-1648

- Protects keyboard from dust
- Constructed of stretchy Lycra/Spandex®
- Adjustable shock cord for snug fit
- Hand washable



61 to 76 Note Keyboard Cover
MODEL: GKC-1540



88 Note Keyboard Cover
MODEL: GKC-1648

X STYLE KEYBOARD STAND

ADJUSTABLE "X" STYLE KEYBOARD STAND WITH RUBBERIZED LEVELING FOOT



Keyboard X-Stand
MODEL: GFW-KEY-1000X

- Numerous Levels Of Adjustability
- Rubberized Leveling Foot
- Heavy Duty Steel Construction With Easy Adjustability
- Min/ Max Height: 3/40 Inches (76/1016 mm)
- 100Lb Weight Capacity (45kg)
- Can Be Used While Seated Or Standing
- Locks In Closed Position To Easily Carry



HEIGHT ADJUSTABLE



RUBBERIZED LEVELING FEET

HEAVY DUTY KEYBOARD X-STAND

HEAVY DUTY ADJUSTABLE "X" STYLE KEYBOARD STAND WITH RUBBERIZED LEVELING FOOT

- Numerous Levels Of Adjustability
- Double Brace Design
- Rubberized Leveling Foot
- Heavy Duty Steel Construction With Easy Adjustability
- Min/ Max Height: 3/40 Inches (76/1016 mm)
- 200Lb Weight Capacity (90 kg)
- Can Be Used While Seated Or Standing
- Locks In Closed Position To Easily Carry

Heavy Duty Keyboard X-Stand
MODEL: GFW-KEY-2000X



KEYBOARD BENCH & X-STAND SET

KEYBOARD X-STAND AND COLLAPSIBLE KEYBOARD BENCH

- Combo Includes (1x) Keyboard X-Stand & (1x) Keyboard Bench - Black Color
- Provides Solution for Both Sitting or Standing Keyboard Playing Positions
- X-Stand Features Five (5) Different Height Settings
- Bench Height Adjusts Between 17.75-20" (451-508mm)
- Stand & Bench Collapse for Easy Transport & Storage
- Non-Slip Rubber Collars on Both Instrument & Floor Contact Points Prevent Movement

Keyboard Bench & X-Stand Set
MODEL: GFW-KEYBENCH-SET



2-TIER KEYBOARD X-STAND

HEAVY DUTY 2-TIER KEYBOARD X-STAND WITH RUBBERIZED LEVELING FEET

- Numerous Levels of Adjustability
- Double Brace Design
- Rubberized leveling feet
- Heavy-duty steel construction
- Min/Max Height Main Frame: 22/38" (965/558 mm)
- 175lb Weight Capacity with Additional 75lb Capacity on Upper Tier
- Locks closed to easily carry and store
- Available in Black and Bright Red Finishes



2-Tier Keyboard X-Stand in Red
MODEL: GFW-KEY-5100RED



2-Tier Keyboard X-Stand
MODEL: GFW-KEY-5100X

THIRD TIER X-STAND ADD ON

ADD ON ACCESSORY FOR 2-TIER KEYBOARD X-STANDS

- Holds one electric, acoustic, and bass guitar
- Finish friendly rubberized cradle padding
- Adjustable width for smaller instruments
- Compact foldable design
- Heavy-duty steel construction

Third Tier X-Stand Add On
MODEL: GFW-KEY-5100XT



ROK-IT X-STAND

ROK-IT TUBULAR "X" STYLE KEYBOARD STAND WITH COMPACT DESIGN

- Black Powder Coated Finish
- Heavy Duty Metal Tube Construction
- Rubberized Keyboard Cradle
- Rubber Feet
- 4 Points of Adjustability
- Collapsible Design

Rok-It X-Stand
MODEL: RI-KEYX-1



RUBBERIZED KEYBOARD CRADLE



ROK-IT DOUBLE X-STAND

WITH ERGONOMIC ADJUSTMENT

NEW!

- Built with double-braced steel construction for exceptional stability, durability, and a professional black finish
- Ergonomic trigger mechanism allows quick, tool-free height changes for both seated and standing play
- Rubber sleeves and feet keep your keyboard firmly in place, preventing shifting during performances
- Supports up to 250 lb (113.4 kg), making it ideal for a wide range of keyboards and playing styles

Double-X Keyboard Stand with Ergonomic Adjust
MODEL: RI-KEYX-20



ADJUSTABLE Z-STYLE KEYBOARD STANDS **NEW!**

WITH WIDTH AND HEIGHT ADJUSTABILITY



FEATURED MODEL
GFW-KEY-Z2000

**Adjustable Z-Style
Keyboard Stand**
MODEL: GFW-KEY-Z2000

**Adjustable Z-Style
Keyboard Stand with
2nd Tier**
MODEL: GFW-KEY-Z2000

- Fully Adjustable Height & Width: Height adjusts from 24" to 38" (61 - 96.5 cm) for seated or standing play; width expands from 20" to 35" (50.8 - 88.9 cm) to fit various keyboard sizes.
- GFW-KEY-Z200 - Integrated 2nd Tier: Upper tier height adjusts from 7" to 12" (17.8 - 30.5 cm) above the lower tier, perfect for stacking a second keyboard or controller.
- Universal Keyboard Compatibility: Supports most keyboards wider than 20" (50.8 cm) for a secure and stable setup.
- Durable & Stable Construction: Black powder-coated square aluminum tubing provides long-lasting strength and reliability.
- Enhanced Protection & Grip: EVA foam padding on contact surfaces prevents scratches and keeps keyboards securely in place.
- Spacious Front-to-Back Design: 22" (55.9 cm) depth ensures ample room for foot pedals and accessories.
- Heavy-Duty Weight Capacity: Supports up to 375 lb (170 kg), perfect for professional and heavy keyboards.
- High Weight Capacity: Supports up to 375 lb (170 kg) on the first tier and 60 lb (27.2 kg) on the second tier.



Z-STYLE KEYBOARD STAND

Z-STYLE KEYBOARD AND MIXER STAND FOR SEATED PLAYING

- Gator Frameworks Z-Style Keyboard & Mixer Stand for Seated Playing
- Fixed Height of 27" for Comfortable-Seated Playing Position
- Fits Most Keyboards Wider than 24"
- 6mm EVA Foam Padding on Contact Surfaces
- Black Powder-Coated Square Aluminum Tube Construction
- Front to Back Measurement: 20.25"/51.44 cm
- Max Weight Capacity: 200 lbs./ 90.72 kg
- Exterior Measurements: 22"/558.8 mm (L) x 26.5"/673.1 mm (W) x 27.5"/698.5 mm (H). Net Weight: 12.2 lbs./5.53 kg

Z-Style Keyboard Stand
MODEL: GFWKEYZ0500



TABLE STYLE KEYBOARD STAND **NEW!**

WITH OPTIONAL SECOND & THIRD TIERS

- DURABLE STEEL CONSTRUCTION: Built for long-lasting support with height-adjustable legs and a sturdy frame designed for professional use.
- FULLY ADJUSTABLE SETUP: Spring-loaded clamping knobs allow height adjustment from 23.5" to 40" (59.7 - 101.6 cm), while support arms extend from 22.5" to 38.5" (57.15 - 97.8 cm) for a perfect keyboard fit.
- STABLE & FLOOR-SAFE DESIGN: Large round floor protectors provide added stability and prevent damage to floors during use.
- TRAVEL-FRIENDLY & PORTABLE: Folding legs and an integrated carrying strap make setup, breakdown, and transport quick and easy.

Table Style Keyboard Stand
MODEL: GFW-KEY-6000

2nd Tier for GFW-KEY-6000
MODEL: GFW-KEY-6000-2T

3rd Tier for GFW-KEY-6000
MODEL: GFW-KEY-6000-3T

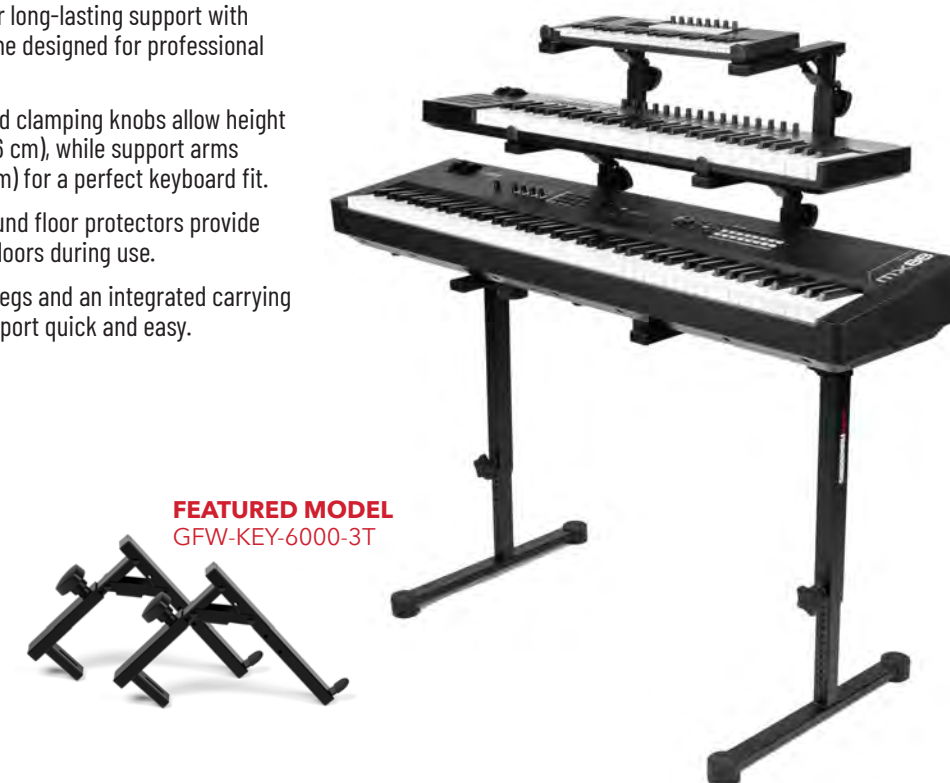

FEATURED MODEL
GFW-KEY-6000-3T

3-TIER KEYBOARD STAND

HOLDS (3) KEYBOARDS, MIXERS AND OTHER LARGE MUSIC EQUIPMENT

NEW!



- Heavy-Duty Steel Frame Designed with Maximum Stability and Support in Mind
- Rugged Rubber Pads on Contact Surfaces Prevent Keyboard Slippage
- Rubber Feet on Floor Contact Surfaces Prevent Stand Slippage
- Depth, Angle, and Height Adjustable Arms Fully Adapt and Customize to Your Specific Keyboard Rig, So You Always Have Full Visibility and Access to Your Keyboard Controls
- Adjustment Line Markings to Quickly and Easily Ensure Your Adjustments are Always Level
- Ergonomic Knobs Designed for Quick and Easy Adjustments
- Black Powder Coat Finish
- Top Tier Height: 48.5-59.2" / 1231.9-1503.68 mm; Middle Tier Height: 38.75-49.2"/984.25-1249.68 mm; Bottom Tier Height: 19-29.75"/482.6-755.65mm
- 32"/812.8 mm Arm Width Holds Most 61 - 88-Key Keyboards
- Stand Footprint: 42"/1066.8 mm x 36.25"/ 920.75mm
- Arm Depth: 24"/609.6 mm
- Max Weight Capacity of 130 lbs./58.97kg.

3-Tier Keyboard Stand
MODEL: GFW-KEY-8500



RUBBER FEET

RUGGED RUBBER PADS

ADJUSTMENT LINE MARKINGS

3-TIER A-FRAME KEYBOARD STAND

WITH WIDTH, ARM HEIGHT, AND ARM DEPTH ADJUSTMENT

NEW!

- **Heavy-Duty Steel Frame:** Road-tested 3-tier design ensures exceptional stability and support for up to three keyboards, even during demanding performances
- **Fully Adjustable Arms:** Ergonomic angle and height adjustments let you customize your setup for maximum comfort, visibility, and easy access to all keyboard controls
- **Secure and Stable:** Safety pins securely lock the arms in place, while non-slip rubber feet keep the stand firmly in position to prevent movement or accidents
- **Ample Space:** A towering 57.5" (146.1 cm) height accommodates three keyboards comfortably, offering a spacious and organized playing experience.
- **Versatile Dimensions:** Width adjusts from 21.2" to 33.7" (53.8 - 85.6 cm) to fit most 49-88-key keyboards; arm depth adjusts from 12.5" to 21" (31.8 - 53.3 cm) to ensure a perfect fit.
- **High Weight Capacity:** Supports up to 120 lbs (54.4 kg) across its three tiers, making it ideal for heavy professional-grade keyboards

3-Tier A-Frame Keyboard Stand
MODEL: GFW-KEY3TIER-A



2-TIER COLUMN STYLE KEYBOARD

LOW PROFILE STEEL FRAME WITH INCLUDED MIC BOOM ARM AND GIG BAG

NEW!

- **Heavy-Duty Steel Construction:** Road-tested frame designed for maximum stability and support in live and studio settings.
- **Secure, Non-Slip Design:** Rugged rubber pads on contact surfaces prevent keyboard slippage, while rubber feet keep the stand firmly in place.
- **Quick & Easy Adjustments:** Ergonomic knobs allow for fast and precise height and angle changes.
- **Compact & Portable:** Folds down to a compact size for easy transport and storage in the included gig bag.
- **Integrated Mic Boom Arm Mount:** Optimizes stage and studio space by allowing a mic boom arm to attach directly to the stand.
- **Adjustable for Comfort:** 51.5" (130.8 cm) overall height with adjustable arms for seated or standing playing positions
- **Spacious & Sturdy Design:** 27.75" (70.5 cm) arm width, 15" (38.1 cm) arm depth, and a stable 35" x 21" (88.9 x 53.3 cm) footprint. Supports up to 120 lb (54.4 kg), ideal for a wide range of keyboards and digital pianos.

Column Keyboard Stand
MODEL: GFW-KEY-4000



UTILITY TABLE TOP WITH X-STAND

HEAVY DUTY DOUBLE X-STAND UTILITY TABLE WITH TABLE TOP

- Numerous Levels Of Adjustability
- Rubberized Leveling Foot
- Heavy Duty Steel Construction With Easy Adjustability
- Min/ Max Height: 3/40 Inches (76/1016 mm)
- 100Lb Weight Capacity (45kg)
- Can Be Used While Seated Or Standing
- Locks In Closed Position To Easily Carry
- Includes table top
- Tabletop Surface Area: 32.25" x 18.25"

Utility Table Top with Double X-Stand

MODEL: GFW-UTL-XSTDTLTOPSET



TABLE TOP FOR X-STANDS

UTILITY TABLE TOP FOR USE WITH MOST X STYLE KEYBOARD STANDS

- Fits most X-style stands
- Turn your keyboard stand into a platform for other components
- Easy to set up and break down

Table Top for X-Stands

MODEL: GFW-UTL-XSTDTLTOP



HEAVY-DUTY KEYBOARD/UTILITY TABLE

HEAVY-DUTY TABLE WITH MULTI-ADJUSTABLE EXTRUSIONS AND BUILT IN LEVELING ASSIST

- Multi Point Adjustability
- Min / Max Height: 26/40 Inches (660/1016 mm)
- Min / Max Width: 29/44 Inches (736/1117 mm)
- Built In Bubble Level for Easy Set-Up
- Heavy Duty Keyboard and Utility Table
- Great For Keyboards, Mixers and DJ Coffins
- 132 Lb Weight Capacity (60 kg)

Heavy Duty Keyboard & Utility Table

MODEL: GFW-UTILITY-TBL



BUILT IN BUBBLE LEVEL



MULTI-POINT ADJUSTABILITY

UTILITY TABLE 2ND TIER ADD ON WITH TILT ADJUSTMENT

NEW!

- COMPATIBLE WITH GATOR UTILITY TABLE: Designed to mount on the Gator Frameworks GFW-UTILITY-TBL Keyboard Table.
- DURABLE CONSTRUCTION: Heavy-duty steel with square tubing and locking insert for a secure hold, finished in black powder coating
- ADJUSTABLE TIER ANGLE: Tilt the second tier in 10° increments to dial in the perfect angle for your 2nd keyboard.
- STABLE AND SECURE: Rubber pads and end tabs keep your keyboard from shifting during use. External dimensions 14.3" (36.2 cm) in height and 13.50" (34.3 cm) in arm length.

Utility Table Tilt 2nd Tier Add-On

MODEL: GFW-UTILITY-2T



ADJUSTABLE T-STAND WORKSTATION

ADJUSTABLE T-STAND FOLDING WORKSTATION WITH 250LB WEIGHT CAPACITY

- Great for keyboards, mixers, DJ controllers, and DJ coffins
- Easy set up with quick-pull leg height adjustment
- Adjustable legs provide various setup configurations
- Compact collapsible design
- Min/Max Height = 25.75" (654mm) / 35.5" (902mm)
- Min/Max Width = 27.375" (695mm) / 47.75" (1213mm)
- Folded dimensions= 3.75" x 3.75" x 47.75" (95mm x 95mm x 1213mm)
- 250 lbs. weight capacity

Adjustable T-Stand Workstation

MODEL: GFW-UTL-WS250



ADJUSTABLE CONFIGURATIONS

PIANO SUSTAIN PEDAL

TRADITIONAL PIANO SUSTAIN PEDAL FOR ELECTRONIC KEYBOARDS

- Provides Traditional-Style Tension for Genuine Feel & Control
- Polarity Switch & 1/4" Input Jack Allow for Universal Keyboard Compatibility
- Non-Slip, Removable Cover Maintains Grip & Protects Pedal
- Textured Rubber Feet Keep Pedal Planted to Floor During Use
- Extra-Long 6' Fixed Cable Length
- Product Dimensions: 8.4"/213mm (L) x 3"/76mm (W) x 2.25"/57mm (H), Net Weight: 1.4 lbs./0.6 kg

Piano Sustain Pedal

MODEL: GFW-KEYSUSTAIN



POLARITY SWITCH

KEYBOARD SUSTAIN PEDAL

WITH HALF DAMPER

NEW!

- **HALF-DAMPER FUNCTION:** Emulates an acoustic piano's damper pedal in "CONTINUOUS" mode; Partially pressing the pedal allows nuanced control of sustain. "SWITCH" mode offers reversed polarity for compatibility with various keyboards.
- **AUTHENTIC FEEL FOR TRADITIONAL PLAYING EXPERIENCE:** Provides natural pedal tension for expressive control, replicating the feel of an acoustic piano pedal.
- **ENHANCED GRIP & STABILITY:** Textured, non-slip pedal cover and rubber feet work together to maintain secure footing and protect the pedal ensuring it stays firmly in place on any surface.
- **EXTRA-LONG 6-FOOT CABLE:** Fixed 6-foot cable offers extended reach and placement flexibility on stage or in the studio.

Keyboard Sustain Pedal with Half Damper

MODEL: GFW-KEYSUSTAIN-HD



POLARITY SWITCH

ADJUSTABLE KEYBOARD BENCH

ROK-IT ADJUSTABLE KEYBOARD BENCH

NEW!

- **Thick Padded Seat:** Wrapped in durable material, the cushioned seat provides superior comfort for extended playing sessions.
- **Sturdy & Durable Build:** Heavy-duty steel construction ensures long-lasting stability and support.
- **Adjustable Height:** Easily adjusts from 18.75" to 20.5" (47.6 - 52 cm) to accommodate different playing preferences.
- **Slip-Resistant Design:** Rubber feet prevent unwanted movement and protect floors from scratches.
- **Strong Weight Capacity:** Supports up to 300 lb (136.1 kg), making it ideal for musicians of all levels.
- **Sleek Black Finish:** Modern, professional look complements any keyboard setup.

Adjustable Keyboard Bench

MODEL: RI-KEY-BNCH-0500



ROK-IT STANDS

HEIGHT ADJUSTABLE PIANO BENCH

RANGING FROM 18" - 22.5" (45.72 - 57.15 CM)

NEW!



- Soft, Upholstered Vinyl Cushion with 1.5"/38mm Padding for Maximum Comfort
- Deluxe Version with Flip-Up Compartment with Convenient Locking Hinge for Storing Sheet Music, Metronome, Polish, & Other Accessories
- Great for Long Performances, Rehearsals & Recording Sessions
- Sturdy Wood Construction with Max Weight Capacity of 350 lbs./159kg
- Compact Design with Non-Slip Feet
- Use on Flat Surface Only
- Minimal Assembly Required
- Product Dimensions: 20.63"/524mm (L) x 12.88"/327mm (W) x 18.88"/480mm (H), Net Weight: 12.2 lbs./5.5 kg

Deluxe Height Adjustable Piano Bench

MODEL: GFW-KEYBENCH-HABK



TRADITIONAL WOODEN PIANO BENCH

TRADITIONAL WOODEN KEYBOARD & PIANO BENCH IN BLACK AND WHITE

- Soft, Upholstered Vinyl Cushion with 1.5"/38mm Padding for Maximum Comfort
- Deluxe Version with Flip-Up Compartment with Convenient Locking Hinge for Storing Sheet Music, Metronome, Polish, & Other Accessories
- Great for Long Performances, Rehearsals & Recording Sessions
- Sturdy Wood Construction with Max Weight Capacity of 350 lbs./159kg
- Compact Design with Non-Slip Feet
- Use on Flat Surface Only
- Minimal Assembly Required
- Product Dimensions: 20.63"/524mm (L) x 12.88"/327mm (W) x 18.88"/480mm (H), Net Weight: 12.2 lbs./5.5 kg



Traditional Wooden Piano Bench In Black

MODEL: GFW-KEYBENCH-WDBK



Traditional Wooden Piano Bench In White

MODEL: GFW-KEYBENCH-WDWH



Deluxe Wooden Piano Bench In Black

MODEL: GFW-KEYBENCH-WDBKS

STANDARD KEYBOARD BENCH

STANDARD BLACK KEYBOARD BENCH WITH DELUXE PADDED SEAT CUSHION

- Deluxe Wrapped Thick Padded Seat Cushion
- Heavy-Duty Steel Construction
- Adjustable Height
- Rubberized Leveling Feet

Standard Keyboard Bench

MODEL: GFW-KEY-BNCH-1



ADJUSTABLE HEIGHT



BAND & ORCHESTRA

When it comes to band instruments, one thing is certain... they need excellent protection. Our well-made cases and bags protect the intricate and sometimes delicate construction of clarinets, flutes, trumpets, saxophones and more!



PERFORMING ARTS
CHAIR WITH SHEET
MUSIC HOLDER

PAGE 156



CASES.....	132	MUSIC STANDS.....	152
BAGS.....	138	ACCESSORIES.....	156
INSTRUMENT STANDS.....	146	FACE MASKS & BELL COVERS.....	157

PRESTO SERIES

PROFESSIONAL-GRADE ABS MOLDED PLASTIC SHELL



Gator Pro Case for Flute
MODEL: GBPC-FLUTE



Gator Pro Case for Clarinet
MODEL: GBPC-CLARINET



Gator Pro Case for Trumpet
MODEL: GBPC-TRUMPET



Gator Pro Case for Trombone
MODEL: GBPC-TROMBONE



Gator Pro Case for Baritone Saxophone
MODEL: GBPC-BARISAX



Gator Pro Case for Tenor Saxophone
MODEL: GBPC-TENORSAX



Gator Pro Case for Alto Saxophone
MODEL: GBPC-ALTOSAX



Gator Pro Case for 4/4 Violin
MODEL: GBPC-VIOLIN44



Gator Pro Case for Single or Double French Horn
MODEL: GBPC-FRHORN



Gator Pro Case for French Horn with Detachable Bell
MODEL: GBPC-FRHORN-DB



Gator Pro Case for 16" Viola
MODEL: GBPC-VIOLA16

ANDANTE SERIES

ABS MOLDED BAND & ORCHESTRA CASES

Molded Case for Trumpet
MODEL: GC-TRUMPET-23



• Durable ABS Design provides a Lightweight and Tough Exterior



• Rubber Feet to Protect Finish from Wear

• Contour Molded Plush-Lined Nest Cradles & Protects Instrument During Transport



Molded Case for 3/4 Violin
MODEL: GC-VIOLIN34-23

- Durable ABS Design provides a Lightweight and Tough Exterior
- Contour Molded Plush-Lined Nest Cradles & Protects Instrument During Transport
- Durable Latches with an Attractive Chrome Finishes for a Professional Look
- Heavy Duty Aluminum Valance provides a Secure Seal
- Durable Easy-Glide Wheels for Easy Transportation
- Reinforced Handle provides a Comfortable and Secure Feel
- Includes Rubber Feet to Protect Finish from Wear



Molded Case for Baritone Sax
MODEL: GC-BARISAX-23

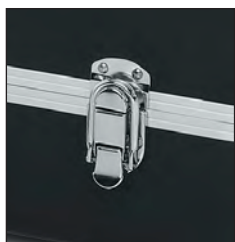

DURABLE CHROME LATCHES



RUBBER WHEELS FOR EASY TRANSPORT



Molded Flute Case
MODEL: GC-FLUTE-B/C



Molded Oboe Case
MODEL: GC-OBOE-23



Molded Clarinet Case
MODEL: GC-CLARINET-23



Molded Alto Sax Case
MODEL: GC-ALTOSAX-23



Molded Tenor Sax Case
MODEL: GC-TENORSAX-23



Molded French Horn Case
MODEL: GC-FRORHN-23



Molded Trombone Case
MODEL: GC-TROMBONE-23

Molded Trombone Case with F-Attachment
MODEL: GC-TROMBONE-F23



Molded Euphonium Case
MODEL: GC-EUPH-23



Molded 3/4 Tuba Case
MODEL: GC-TUBA34-23



Molded 4/4 Tuba Case
MODEL: GC-TUBA44-23



Molded 1/4 Violin Case
MODEL: GC-VIOLIN14-23



Molded 1/2 Violin Case
MODEL: GC-VIOLIN12-23



Molded 13 - 13.5" Viola Case
MODEL: GC-VIOLA13-23



Molded 15-15.5" Viola Case
MODEL: GC-VIOLA15-23



Molded 4/4 Violin Case
MODEL: GC-VIOLIN44-23



Molded 16-16.5" Viola Case
MODEL: GC-VIOLA16-23

ADAGIO PRO SERIES

RIGID ABS LIGHTWEIGHT MOLDED BAND & ORCHESTRA CASES



Professional and Long-Lasting Exterior is made of Black 1680D Nylon

Two (2) Large Exterior Pocket for Convenient Storage and Quick Access

- Rigid ABS Frame provides a Lightweight and Highly Durable Case
- Professional and Long-Lasting Exterior is made of Black 1680D Nylon
- Contour Molded Plush-Lined Nest Cradles & Protects Instrument During Transport
- Discrete Hideaway Backpack Straps for Convenient Travel
- Metal Hooks Allow for Traveling with a Convenient Shoulder Strap
- Two (2) Large Exterior Pocket for Convenient Storage and Quick Access
- High Quality Custom Zippers for Extensive Durability Reinforced Micro-Leather Handle provides a Comfortable and Secure Feel
- Includes Rubber Feet to Protect Finish from Wear



HIGH QUALITY ZIPPERS



HIDEAWAY BACKPACK STRAPS



Reinforced Micro-Leather Handle provides a Comfortable and Secure Feel

Contour Molded Plush-Lined Nest Cradles & Protects Instrument During Transport

Two (2) Large Exterior Pocket for Convenient Storage and Quick Access

Lightweight Pro Case for Trumpet
MODEL: GL-TRUMPET-PRO



Lightweight Pro Case for Alto Sax
MODEL: GL-ALTOSAX-PRO



Lightweight Pro Case for Tenor Sax
MODEL: GL-TENORSAX-PRO

ADAGIO SERIES

RIGID EPS LIGHTWEIGHT CONTOUR MOLDED BAND & ORCHESTRA CASES

Rigid EPS Design provides a Lightweight and Tough Exterior

Contour Molded Plush-Lined Nest Cradles & Protects Instrument During Transport

Exterior Pocket for Convenient Storage and Quick Access

Lightweight Tenor Sax Case
MODEL: GL-TENORSAX-S23



- Rigid EPS Design provides a Lightweight and Tough Exterior
- Contour Molded Plush-Lined Nest Cradles & Protects Instrument During Transport
- Comfortable Shoulder Strap for Convenient Travel
- Exterior Pocket for Convenient Storage and Quick Access
- High Quality Custom Zippers for Extensive Durability
- Reinforced Handle provides a Comfortable and Secure Feel
- Includes Rubber Feet to Protect Finish from Wear



Lightweight 1/2 Violin Case
MODEL: GL-VIOLIN12-23



RUBBER FEET



HIGH QUALITY ZIPPERS



Lightweight Flute Case
MODEL: GL-FLUTE-23



Lightweight Oboe Case
MODEL: GL-OBOE-23



Lightweight Clarinet Case
MODEL: GL-CLARINET-23



Lightweight Alto Sax Case
MODEL: GL-ALTOSAX-R23



Lightweight Alto Sax Case
MODEL: GL-ALTOSAX-S23



Lightweight Tenor Sax Case
MODEL: GL-TENORSAX-R23



Lightweight Trumpet Case
MODEL: GL-TRUMPET-R23



Lightweight Trumpet Case
MODEL: GL-TRUMPET-S23



Lightweight Trombone Case
MODEL: GL-TROMBONE-23



Lightweight French Horn Case
MODEL: GL-FRHORN-23



Lightweight 3/4 Violin Case
MODEL: GL-VIOLIN34-23



Lightweight 4/4 Violin Case
MODEL: GL-VIOLIN44-23



Lightweight 15-15.5" Viola Case
MODEL: GL-VIOLA15-23



Lightweight 16-16.5" Viola Case
MODEL: GL-VIOLA16-23

ALLEGRO SERIES

LIGHTWEIGHT DURABLE NYLON BAG IN PROFESSIONAL BLACK CANVAS



- Lightweight Durable Nylon Bag in Professional Black Canvas
- Thick Double Banded Cotton Lining Cradles & Protects Instrument During Transport
- Internal Storage Bag for Mouthpieces with External Pocket for Additional Accessories
- Comfortable, Interchangeable Backpack or Shoulder Strap for Convenient Travel
- Thick Plastic Base provides Sturdiness and Stability
- High Quality Custom Zippers for Extensive Durability
- Includes Rubber Feet to Protect Canvas

Gator Gig Pro Bag for Large Size Tuba
MODEL: GBP-TUBA-L

Gator Gig Pro Bag for Medium Size Tuba
MODEL: GBP-TUBA-M



Gator Gig Pro Bag for Soprano Saxophone
MODEL: GBP-S-TRUMPET

Gator Gig Pro Bag for Alto Saxophone
MODEL: GBP-S-ALTOSAX

Gator Gig Pro Bag for Tenor Saxophone
MODEL: GBP-S-TENSAX



Gator Gig Pro Bag for Trumpet
MODEL: GBP-S-TRUMPET

Gator Gig Pro Bag for Trombone
MODEL: GBP-S-TROMBONE



Gator Gig Pro Bag for 1/4 Cello
MODEL: GOPB-CELLO14

Gator Gig Pro Bag for 1/2 Cello
MODEL: GOPB-CELLO12

Gator Gig Pro Bag for 3/4 Double Bass
MODEL: GOPB-BASS34

Gator Gig Pro Bag for 3/4 Cello
MODEL: GOPB-CELLO34

Gator Gig Pro Bag for 4/4 Cello
MODEL: GOPB-CELLO44

Gator Gig Pro Bag for 1/2 Double Bass
MODEL: GOPB-BASS12

LARGO SERIES

EPS HYBRID LIGHTWEIGHT CONTOUR MOLDED INSTRUMENT BAGS



Gator Lightweight Beginner Case for 3/4 Violin
MODEL: GBO-VIOLIN44

- Durable EPS Hybrid Design Provides Lightweight Protection
- Contour Molded Plush-Lined Nest Cradles & Protects Instrument During Transport
- Backpack and Shoulder Straps for Convenient Travel
- Exterior Pocket for Convenient Storage and Quick Access
- High Quality Custom Zippers for Extensive Durability



HIGH QUALITY ZIPPES



DURABLE HANDLE



Gator Lightweight Beginner Case for 1/2 Violin
MODEL: GBO-VIOLIN12



Gator Lightweight Beginner Case for 3/4 Violin
MODEL: GBO-VIOLIN34



Gator Lightweight Beginner Case for 15 - 15.5" Viola
MODEL: GBO-VIOLA15



Gator Lightweight Beginner Case for 16 - 16.5" Viola
MODEL: GBO-VIOLA16



Gator Lightweight Case for Flute
MODEL: GBB-FLUTE



Gator Lightweight Case for Oboe
MODEL: GBB-OBOE



Gator Lightweight Case for Clarinet
MODEL: GBB-CLARINET



Gator Lightweight Case for Trombone
MODEL: GBB-TROMBONE



Gator Lightweight Case for Trumpet
MODEL: GBB-TRUMPET



Gator Lightweight Case for Alto Saxophone
MODEL: GBB-ALTOSAX



Gator Lightweight Case for Tenor Saxophone
MODEL: GBB-TENORSAX



Gator Lightweight Case for Cello 1/4
MODEL: GBO-CELLO14



Gator Lightweight Case for Cello 1/2
MODEL: GBO-CELLO12



Gator Lightweight Case for Cello 3/4
MODEL: GBO-CELLO34



Gator Lightweight Case for Cello 4/4
MODEL: GBO-CELLO44



Gator Lightweight Case for Bass 1/2
MODEL: GBO-BASS12

Gator Lightweight Case for Bass 3/4
MODEL: GBO-BASS34

Gator Lightweight Case for Bass 1/4
MODEL: GBO-BASS14

MODULAR MUTE BAGS

CARRY & STORAGE BAGS FOR LOW & HIGH BRASS PLAYERS

- Durable 600D Fabric Provides a Rigid Weather-Resistant Structure
- Interior Features up to 6 (Six) Large Thick Cotton Compartments to Safely Store Mutes
- Modular Walls with Fastener Tape Allow for Customized Configurations
- Comfortable Shoulder Strap for Quick On-The-Go Travel
- Elastic Band on Lid Allows Bag to Hang from a Music Stand for Quick Safe Access; Available for Small and Medium Sizes Only
- Three (3) Exterior Pockets for Convenient Additional Accessories Storage
- High Quality Custom Zippers for Extensive Durability
- Includes Rubber Feet to Protect Fabric from Wear

FEATURED MODEL
GBNO-MUTEBAG-S



Small Modular Mute Bag for High Brass Players; Fits up to (3) Mutes

MODEL: GBNO-MUTEBAG-S



FEATURED MODEL
GBNO-MUTEBAG-M

Medium Modular Mute Bag for High Brass Players; Fits up to (4) Mutes

MODEL: GBNO-MUTEBAG-M

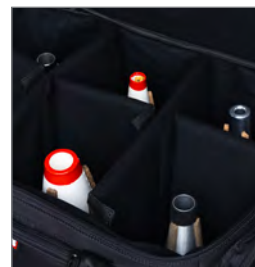

ADJUSTABLE DIVIDERS

Large Modular Mute Bag for Low Brass Players; Fits up to (4) Mutes

MODEL: GBNO-MUTEBAG-L



FEATURED MODEL
GBNO-MUTEBAG-L



SOFT MUTE INSERTS

Extra Large Modular Mute Bag for Low Brass Players; Fits up to (6) Mutes

MODEL: GBNO-MUTEBAG-XL

STUDENT PERCUSSION KITS

ROLLING STORAGE BAG FOR STUDENT BELL KITS, SNARE DRUMS, AND HARDWARE

Student Bells and Snare Combo Kit Rolling Bag
MODEL: GP-COMBOKIT



- Durable Fabric to Handle Daily Travel and Usage
- Telescopic Luggage Handle and Durable Wheels for Easy Transport
- High Quality Custom Zippers for Extensive Durability
- Bag Only - Instruments and Accessories Not Included
- Exterior Pocket for Additional Accessories
- Built in Stick Sleeves to Hold Drumsticks and Mallets
- **GP-COMBOKIT:** Designed to Carry Student Bell Kits, 13" Snare Drum, and Hardware
- **GP-PERCKIT:** Designed to Carry Student Bell Kits and Hardware
- **GP-SNAREKIT:** Designed to Carry 13" Snare Drum and Hardware

Student Snare Drum Kit Rolling Bag
MODEL: GP-SNAREKIT



Student Bell Kit Rolling Bag
MODEL: GP-PERCKIT



BAND & ORCHESTRA STANDS

INSTRUMENT & MUSIC STANDS



TALL SAXOPHONE STAND

TALL TRIPOD STAND FOR ALTO OR TENOR SAXOPHONE

- Safe & Convenient: Keeps Instrument in Reach when Not in Use
- Expanded Height Adjustment for Playing in Standing Position
- Prevents Contact Damage to Keys by Holding Sax Safely on its Bell
- Height-Adjustable Bottom Yoke Provides Custom Fitment for Different-Size Saxes
- Dual, Rubberized Yokes Protect Instrument from Scratches
- Legs with Non-Slip Feet Collapse Down for Easy Travel

Tall Saxophone Stand
MODEL: GFW-BNO-SAXTALL

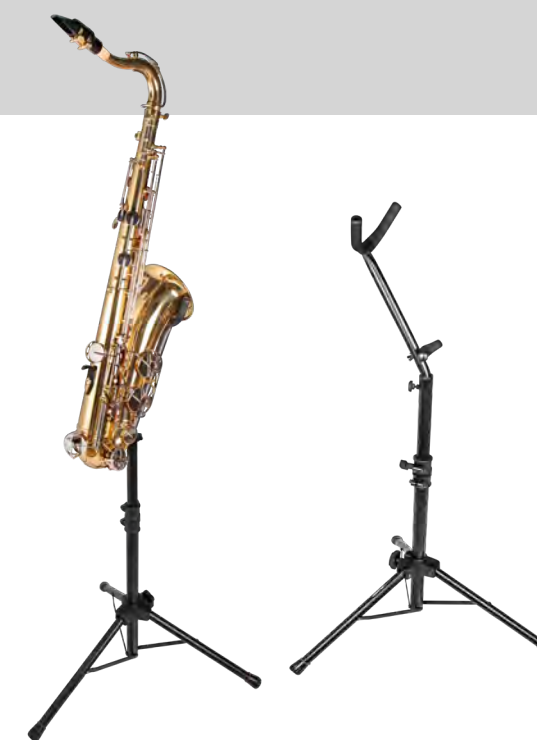

CLARINET/FLUTE STAND

WEIGHTED ROUND BASE STAND FOR CLARINET OR FLUTE

- Safe & Convenient: Keeps Instrument in Reach when Not in Use
- Holds Instrument Upright on Soft Peg
- Fits Most Standard-Size Clarinets & Flutes
- 6.5"/165mm-Wide Circular Base with Non-Slip Feet Provides Extra Stability
- Peg Attachment Unscrews from Base for Compact Transport & Storage
- Black Powder-Coated Steel Construction

Clarinet/Flute Stand
MODEL: GFW-BNO-CLRFLU

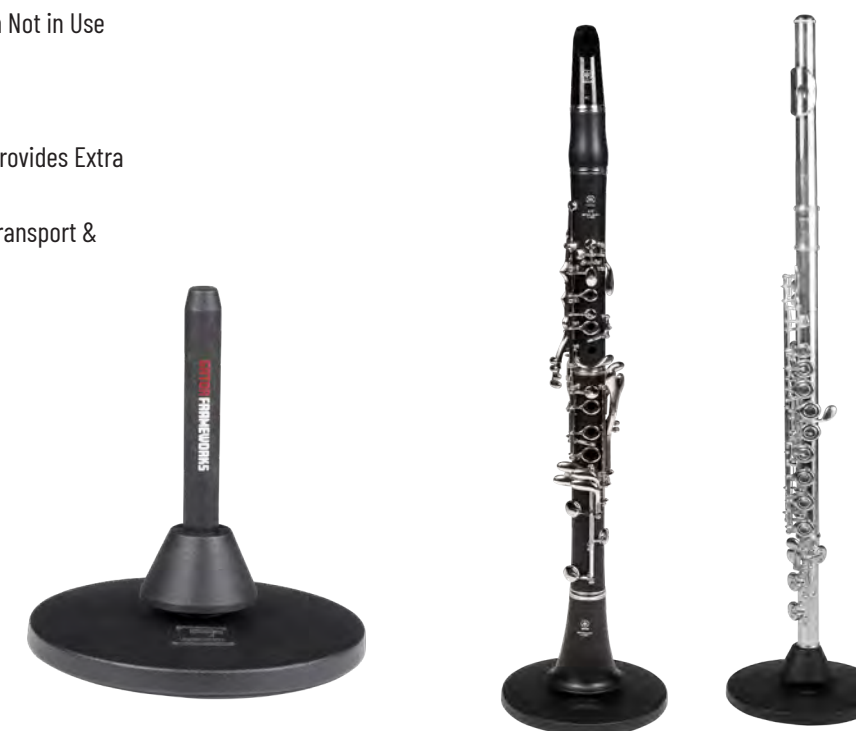

TRIPOD STYLE STANDS

TRIPOD STAND FOR TROMBONE, TRUMPET AND SAXOPHONE

- Tripod Stand for Trombone, Trumpet, Baritone Saxophone and Alto or Tenor Sax with Clarinet / Flute Peg Attachment
- Safe & Convenient: Keeps Instrument in Reach when Not in Use
- Elevated Rest Positions keeps Locked Slide from Scraping Floor
- Prevents Contact Damage to Keys by Holding Instrument Safely on its Bell
- Height-Adjustable Bottom Yoke Provides Custom Fitment for Different-Size Saxophones
- Dual, Rubberized Yokes Protect Instrument from Scratches
- Legs with Non-Slip Feet Collapse Down for Easy Travel



Trumpet Stand
MODEL: GFW-BNO-TRUMPET



Trombone Stand
MODEL: GFW-BNO-TBONE



Alto or Tenor Saxophone & Clarinet/Flute Combo Stand
MODEL: GFW-BNO-SAXFLU



Baritone Saxophone Stand
MODEL: GFW-BNO-SAXBARI



Tripod Stand for Soprano Sax
MODEL: GFW-BNO-SOPSAX

RECITAL ORCHESTRA STANDS

ADJUSTABLE STANDS FOR VIOLIN & VIOLA

- Safe & Convenient: Keeps Instrument in Reach when Not in Use
- Designed to Accommodate both Violin and Viola
- Padded Foam Yoke Keeps Neck Supported and Secure
- Padded Foam Cradle is Finish and Varnish Friendly
- Bow Hanger Keeps It Stored Off the Floor and Easily Accessible
- Wide Base Provides a Secure Foundation for the Stand
- Heavy-Duty Steel Construction
- Legs with Non-Slip Feet Collapse for Easy Travel

Violin & Viola Stand
MODEL: GFW-BNO-VLNVLA



RECITAL ORCHESTRA STANDS

ADJUSTABLE STANDS FOR CELLO

- Safe & Convenient: Keeps Instrument in Reach when Not in Use
- Designed to Accommodate both Cello
- Padded Foam Yoke Keeps Neck Supported and Secure
- Padded Foam Cradle is Finish and Varnish Friendly
- Bow Hanger Keeps It Stored Off the Floor and Easily Accessible
- Wide Base Provides a Stable Foundation for the Stand
- Heavy-Duty Steel Construction
- Legs with Non-Slip Feet Collapse for Easy Travel

Cello Stand
MODEL: GFW-BNO-CELLO



FRENCH HORN STAND

A-FRAME STAND FOR STANDARD FRENCH HORN

- Safe & Convenient: Keeps Instrument in Reach when Not in Use
- Prevents Contact Damage to Keys
- Reclined Angle Prevents Horn from Falling Forward
- Adjustable / Lockable Width & Collapsible Design
- Rubberized Cradle & Backrest Protect Instrument Finish from Scratches
- Non-Slip Rubber Feet
- Black Powder-Coated Steel Construction

French Horn Stand
MODEL: GFW-BNO-FRHORN



CLAMPING MUTE REST

STAND-CLAMPING REST FOR 4 HORN MUTES

- Stand-Clamping Rest for Four (4) Various-Size Instrument Mutes
- Clamps to Music Stand Tubing for Quick & Easy Access to Mutes; Min/Max Tubing Diameter: 0.51 - 1.25" (13 - 32mm)
- Holds Trumpet, Cornet, French Horn, & Trombone Mutes
- Extended Post Provides Clearance from Music Stand Trays
- Four (4) EVA Foam-Lined Rings Swivel to Desired Positions; Ring Diameters: (2x) 3"/76mm; (2x) 2.5"/64mm
- Safest Way to Keep Mutes Ready for Use at Any Time
- Folds for Easy Storage & Transport

Clamping Mute Rest
MODEL: GFW-BNO-MUTEREST4



INSTRUMENT WALL HANGERS

RECITAL SERIES WALL HANGERS FOR WIND INSTRUMENTS

- Safely Display Trumpet for Everyone to See
- Keeps Instrument Safe and Ready to Go
- Rubberized Stopper keeps inside of Bell Safe and Secure
- Post provides extra Stability and Protection
- Quick and Easy Installation



Horizontal Wall Hanger for Trumpet
MODEL: GFW-TRUMPETHNGRBLK-H

Wall Hanger for Trombone
MODEL: GFW-TBONEHNGRBLK

Wall Hanger for Trumpet
MODEL: GFW-TRUMPETHNGR-BLK

Wall Hanger for Saxophone
MODEL: GFW-SAXHNGR-BLK

LIGHTWEIGHT SHEET MUSIC STAND

LIGHTWEIGHT SHEET MUSIC STAND

- Lightweight Sheet Music Stand
- Compact, Collapsible Tripod Base Design
- Easy-Grip Tension Knob Height Adjustment
- 18.75" Perforated Sheet Music / Portfolio Tray
- Maximum Height of 45" a
- Removable, Red, Anti-Trip Safety Rings on Feet
- Ships in Signature Frameworks Retail Friendly Packaging

Lightweight Music Stand
MODEL: GFW-MUS-0500



STANDARD SHEET MUSIC STAND

STANDARD SHEET MUSIC STAND WITH EASY LIFT BRUSHED METAL BASE

- Large 20" Bookplate for Sheet Music
- Brushed Metal Stand with Easy Lift
- Perfect for Classrooms, Churches, and all Music Ensembles
- Convenient Knob for Easy Bookplate Adjustment
- Height Adjustable: 38" - 60"
- Removable Rubber Feet Caps Keep Floors Safe from Scruffs and Damage

Standard Music Stand
MODEL: GFW-MUS-1001



HEIGHT ADJUSTMENT

RUBBERIZED FEET

DELUXE SHEET MUSIC STAND

TRIPOD STYLE SHEET MUSIC STAND WITH DELUXE SINGLE HAND CLUTCH HEIGHT ADJUSTMENT

- Deluxe Tripod Sheet Music Stand
- Soft Grip One Handed Height Adjustment Clutch
- Collapsible Design
- 19 Inch Width (482 mm)
- Min / Max Height: 26/43 Inches (660/1092 mm)
- Red Safety Trim On Feet (Removable)

Deluxe Music Stand
MODEL: GFW-MUS-2000



HEIGHT ADJUSTMENT CLUTCH

ROK-IT SHEET MUSIC STAND

HEAVY DUTY SHEET MUSIC STAND WITH FRICTION CLUTCH HEIGHT ADJUSTMENT

- Black Powder Coated Finish
- Heavy Duty Metal Tube Construction
- Non Slip Rubber Feet
- Carry Bag Included

Rok-It Music Stand
MODEL: RI-MUSICSTD1



WOODEN CONDUCTOR STAND

MUSIC STAND WITH TRIPOD BASE AND WOODEN BOOKPLATE

- Perfect for Recital Performers and Conductors
- Bookplate Features Premium Wood Finish
- Large Wooden Bookplate for Scores and Oversized Music
- Designed for Soloists to Reduce Page Turns
- Height Adjustable: 24.75 - 42.5"
- Legs with Non-Slip Feet Collapse Down for Easy Travel

Tripod Style Wooden Conductor Music Stand
MODEL: GFW-MUS-4000

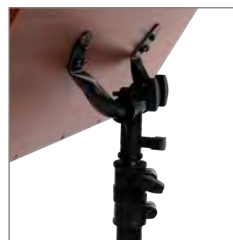

HEIGHT ADJUSTMENT



RED SAFETY RING

WOODEN CONDUCTOR STAND

MUSIC STAND WITH TRADITIONAL BASE AND WOODEN BOOKPLATE

- Large Wooden Bookplate for Scores and Oversized Music
- Perfect for Soloists to Reduce Page Turns
- Designed for Recital Performers and Conductors
- Bookplate Features Premium Wood Finish
- Height Adjustable: 27.5 - 45.5"
- Brushed Metal Stand with Easy Lift

Traditional Style Wooden Conductor Music Stand
MODEL: GFW-MUS-5000



SHEET MUSIC STAND CARTS

- Holds and Stores up to 12 or 25 Sheet Music Stands
- High Quality Steel Construction Provides Reliable Durability for Long Term Daily Use
- Perfect for Classrooms, Churches, and all Music Ensembles
- Durable Easy Rolling Lockable Wheels help Transport Stands from Site to Site
- Compatible with many Traditional Music Stands

Carrier Cart for 12 Sheet Music Stands
MODEL: GFW-MUSSTD-CART12

Carrier Cart for 25 Sheet Music Stands
MODEL: GFW-MUSSTD-CART25



LOCKABLE RED CASTERS



BLACK POWDER COATED STEEL CONSTRUCTION



FEATURED MODEL
GFW-MUSSTD-CART25

LED LAMP FOR MUSIC STANDS

CLIP-ON LED MUSIC LAMP WITH ADJUSTABLE NECK

- Battery Powered LED Lamp for use with Music Stand Trays, Pedal Boards, Mixers and More
- Clamp on Design Allows Attachment in a Variety of Applications
- Adjustable Gooseneck Design for Great Flexibility
- High and Low Illumination Settings
- Includes USB Power Cable and (3) AA Batteries
- Convenient Nylon Tote Bag for Transport
- Available in Standard and Red LED

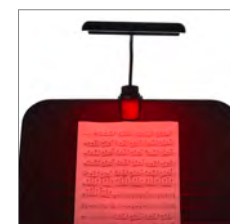
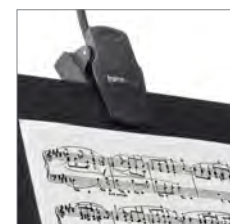

Red Led Lamp For Music Stands
MODEL: GFWMUSLEDR

LED Lamp for Music Stands
MODEL: GFW-MUS-LED



PERFORMING ARTS CHAIR WITH SHEET MUSIC HOLDER

NEW!

Performing Arts Chair
MODEL: GFW-BNO-PACHAIR

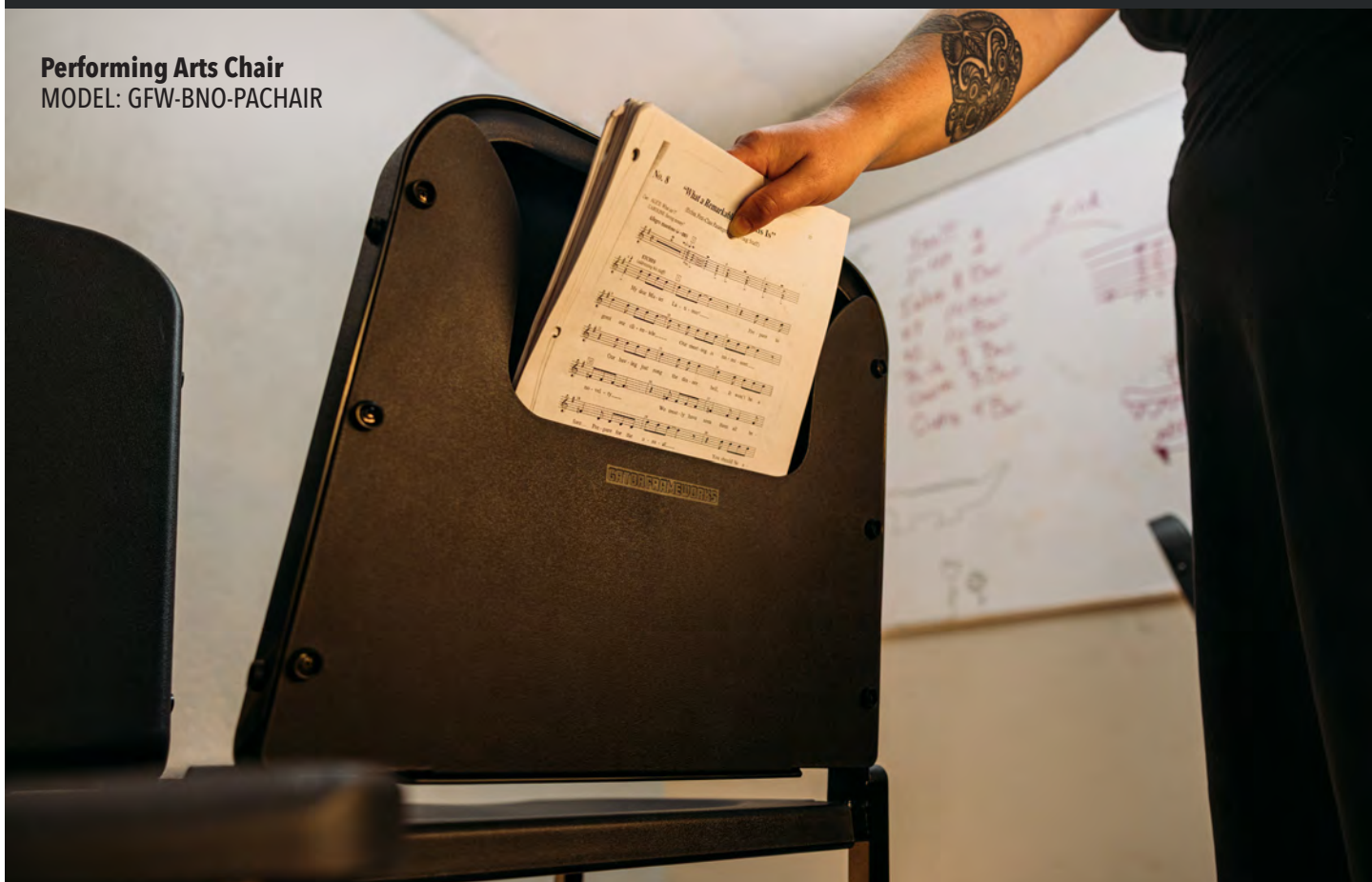

- Features a 97-degree "band-pitch style" seat-to-backrest angle that promotes proper posture and optimal breathing during performances
- Built with a 7/8", 16-gauge square steel frame and a 14-gauge rear seat brace for long-lasting strength, stability, and support
- Integrated sheet music compartment keeps materials within reach, while polyethylene floor glides prevent scratching
- Designed to stack up to 18 chairs high on chair carts, with protective bumpers to prevent frame damage during storage



INTEGRATED SHEET
MUSIC COMPARTMENT



NON-SLIP RUBBER FEET

PERFORMING ARTS CHAIR CART

HOLDS UP TO (18) FRAMEWORKS PERFORMING ARTS CHAIRS

NEW!

- **RUGGED STEEL CONSTRUCTION:** Built with a 17-gauge square-steel frame and black powder-coated finish for maximum durability in demanding environments.
- **HIGH CAPACITY:** Transports up to 15-18 Gator Frameworks GFW-BNO-PACHAIR performing arts chairs, ideal for schools, theaters, and event setups.
- **SECURE HANDLING & CONTROL:** Reinforced 16-gauge steel side handles provide balanced lifting and precise steering for easy loading and unloading.
- **SMOOTH, HEAVY-DUTY MOBILITY:** Equipped with four hard-rubber casters (two swivel, two fixed) and supports up to 332 lb without flexing or warping.

Performing Arts Chair Cart
MODEL: GFW-BNO-PACHAIR-CART



DELUXE SAXOPHONE STAPS

NEW!

- **ERGONOMIC COMFORT:** Designed with premium neoprene and a soft backing, our sax strap evenly distributes weight across your neck and shoulders, reducing pressure and minimizing fatigue for longer, more comfortable playing sessions
- **EASY ADJUSTABILITY:** Effortlessly adjust the strap to find your perfect fit, ensuring compatibility with most saxophones and a secure, personalized playing experience.
- **RELIABLE ATTACHMENT:** Featuring a durable pivot hook, this strap offers quick and reliable instrument attachment, giving you peace of mind while performing or practicing.
- **ENHANCED STABILITY:** The ergonomic design minimizes unwanted movement, keeping your saxophone stable and securely positioned for optimal performance.

**Deluxe Neoprene
Saxophone Strap**
MODEL: G27NEO-BLK

**Deluxe Neoprene
Saxophone Strap - XL**
MODEL: G27NEO-BLK-XL

**Deluxe Neoprene
Saxophone Strap - Junior**
MODEL: G27NEO-BLK-JR



BEGINNER SAXOPHONE STRAP

- Gator Alto and Tenor Saxophone Strap
- Safely Supports Saxophone with Comfortable Fabric
- Designed to Support Alto and Tenor Saxes
- Quick and Easy Height Adjustment
- Quality Plastic Clip for Getting Sax On and Off Easily



Beginner Saxophone Strap
MODEL: GBNO-SAXSTRAP-BLK

BLACK BELL COVER WITH MERV 13 FILTER

WIND INSTRUMENT DOUBLE-LAYER COVER FOR VARIOUS BELL SIZES



- Made to meet the recommendations set forth by the NFHS' Performing Arts Aerosol Study
- Covers bell opening of instrument to greatly reduce the spread of aerosols
- Breathable design with little to no back pressure or acoustic loss during performance
- Equipped with removable MERV-13 Filter (Do not wash filter. For best practices, replace after 1-2 months)
- Elastic closure & cord lock keeps mask secured
- Reusable & hand washable Non-woven polypropylene fabric

**Pack of five (5) MERV-13 replacement filters sold separately

Bell Sizes Ranging from 2-3"
MODEL: GBELLCVR0203BK
Fits Clarinet & Oboe

Bell Sizes Ranging from 8-9"
MODEL: GBELLCVR0809BK
Fits Trombone, Baritone Saxophone, Baritone Horn & Alto Horn

Bell Sizes Ranging from 14-15"
MODEL: GBELLCVR1415BK
Fits Tuba & Other Large Bell Instruments

Bell Sizes Ranging from 20-21"
MODEL: GBELLCVR2021BK
Fits Marching Tuba & Other Large Bell Instruments

Bell Sizes Ranging from 27-29"
MODEL: GBELLCVR2729BK
Fits Sousaphone, Helicon & Contrabass Tuba

Bell Sizes Ranging from 4-5"
MODEL: GBELLCVR0405BK
Fits Trumpet, Cornet, Alto/Tenor Saxophone, Bass Clarinet, & Similar-Size Instruments

Bell Sizes Ranging from 10-11"
MODEL: GBELLCVR1011BK
Fits Mellophone & Euphonium

Bell Sizes Ranging from 16-17"
MODEL: GBELLCVR1617BK
Fits Tuba & Other Large Bell Instruments

Bell Sizes Ranging from 22-23"
MODEL: GBELLCVR2223BK
Fits Tuba, Helicon & Other Large Bell Instruments

Bell Sizes Ranging from 30-32"
MODEL: GBELLCVR3032BK
Fits Sousaphone & Contrabass/Subcontrabass Tuba

Bell Sizes Ranging from 6-7"
MODEL: GBELLCVR0607BK
Fits Trombone, Flugelhorn, Baritone Saxophone, Tenor Saxophone, & Alto Horn

Bell Sizes Ranging from 12-13"
MODEL: GBELLCVR1213BK
Fits Tuba & Other Large Bell Instruments

Bell Sizes Ranging from 18-19"
MODEL: GBELLCVR1819BK
Fits Tuba & Other Large Bell Instruments

Bell Sizes Ranging from 24-26"
MODEL: GBELLCVR2426BK
Fits Sousaphone, Tuba & Helicon

**Disclaimer: These masks have not been tested by the FDA, CDC or any other official organization to conclude that they prevent the transmission of viruses*

WIND INSTRUMENT BELL COVERS

FRENCH HORN BELL COVER WITH HAND ACCESS, 11-13"



HAND ACCESS SLOT

- Wind instrument double-layer bell cover with hand access for french horn bell sizes ranging from 11 to 13" (279/330mm) in diameter - black color
- Covers bell opening of instrument to greatly reduce the spread of aerosols
- Hand access slot for proper grip of horn
- Elastic closure keeps mask secured to bell opening
- Reusable & hand washable Lycra fabric

French Horn Bell Cover, 11-13"
MODEL: GBELLCVR1113FHBK

SINGING & WIND INSTRUMENT FACE MASK

DOUBLE & TRIPLE-LAYERED FACE MASKS FOR SINGING AND WIND INSTRUMENTS

- Helps reduce the spread of aerosols during instrument play and singing
- Made to meet the recommendations set forth by the NFHS' Performing Arts Aerosol Study
- Patent pending design allows user to play instrument without having to remove face covering
- Great to drink through during travel, events, exercise, and any situation where a mask is worn
- Cotton flap on mouth opening features magnetic connections to keep it open or closed
- Adjustable elastic straps for increased comfort
- Reusable and hand washable
- Cotton and polyester fabric
- Disclaimer: These masks have not been tested by the FDA, CDC or any other official organization to conclude that they prevent the transmission of viruses



FLUTE SLOT ALLOWS USER TO PLAY INSTRUMENT WITHOUT HAVING TO REMOVE FACE COVERING

Small Singing Face Mask
MODEL: GBOMSNGRMSK-S

Medium Singing Face Mask
MODEL: GBOMSNGRMSK-M

Large Singing Face Mask
MODEL: GBOMSNGRMSK-L

X-Small Wind Instrument Face Mask
MODEL: GBOM-XSMALLBK

Small Wind Instrument Face Mask
MODEL: GBOM-SMALLBK

Medium Wind Instrument Face Mask
MODEL: GBOM-MEDIUMBK

Large Wind Instrument Face Mask
MODEL: GBOM-LARGBK

Wind Instrument Face Mask for Flutes & Piccolos
MODEL: GBOMFLUTEPIK-MSK

PERCUSSION

Drummers have it rough! Drums, hardware, cymbals, accessories... it's a lot to move from place to place. With our range of cases and bags for all of your gear - we can get you there organized without accidents. Just maybe your band mates will help you load in this time... who are we kidding. At least some of our stuff has wheels!



NEW!
AIR GLIDE SERIES
DRUM THRONES &
BACKRESTS
PAGE 180

CASES.....	162	WORLD CASES & BAGS.....	184
BAGS.....	168	MARCHING CASES.....	185
CYMBAL CASES & BAGS.....	171		
ACCESSORIES.....	173		

GATOR GROOVES SERIES

REAR STACKING HARDSHELL PERCUSSION CASES

NEW!

- Durable Weather Resistant Roto-Molded Construction
- Plush 12mm Padded Interior Lined with Red Micro-Velvet Fabric Provides Additional Protection
- Red Micro-Velvet Fabric is Double Stitched Through the Shell to Permanently Secure Foam Lining
- Gator Grooves Exclusive Rear-Aligned Stacking for Easy Transport and Storage
- Gator Grooves Exclusive Design Channels Interlock with Pedestal Feet for Ultimate Stacking Stability
- Rugged Spring-Loaded 90 Degree Stop Handles - 3 on Each Bass Drum Case

Gator Grooves Rock Pack
MODEL: GPCRACKPACK

Sizes In Set:

10" x 8"	22" x 18"
12" x 9"	
16" x 16"	

Gator Grooves Fusion Pack
MODEL: GPCFUSIONPACK

Sizes In Set:

10" x 7"	20" x 16"
12" x 8"	
14" x 14"	

 **The Gator Grooves Series comes with a Limited Lifetime Warranty against cracking.**



SNARE

13" x 5.5" NEW! GPC1355SD	14" x 5" NEW! GPC1405SD	14" x 6.5" GPC1465SD
13" x 7" GPC1307SD	14" x 5.5" GPC1455SD	14" x 8" GPC1408SD

TOM

10" x 7" GPC1007	12" x 9" GPC1209	14" x 10" NEW! GPC1410	16" x 14" GPC1614
10" x 8" GPC1008	13" x 9" GPC1309	14" x 12" GPC1412	16" x 16" GPC1616
12" x 8" GPC1208	13" x 10" GPC1310	14" x 14" GPC1414	18" x 16" GPC1816

BASS

20" x 14" GPC2014BD	22" x 14" GPC2214BD	24" x 14" GPC2414BD
20" x 16" GPC2016BD	22" x 16" GPC2216BD	24" x 16" GPC2416BD
20" x 18" GPC2018BD	22" x 18" GPC2218BD	

HARDWARE

33" x 15" NEW! GPC3315DHW	22" NEW! GPCCYM22W
42" x 16" NEW! GPC4216DHW	24" NEW! GPCCYM24W



FEATURED MODEL
GPC3315DHW

FEATURED MODEL
GPCCYM22W

PROTECTOR CLASSIC SERIES

ROTO MOLDED DRUM CASES



- Recognized as the industry standard rotationally molded drum cases
- Provides strength, durability, and simplicity for almost any drum size
- The rotational molding process gives added strength and durability to case corners and provides water resistance that non-rotomolded cases can't match
- Comes with a limited, lifetime warranty against cracking
- The multi-tom case features rounded pockets to make room for floor tom leg mounts
- The 34" maximum depth allows for any combination of floor toms (up to 16" diameter), mounted toms, or snares

Standard Set Cases; Classic Series
MODEL: GP-PCSTANDARD

Sizes In Set:	
12" x 10"	22" x 18"
13" x 11"	14" x 6.5"
16" x 16"	

CLASSIC SERIES TOM DRUM CASES

8" x 8" Classic Series Tom Case
MODEL: GP-PC0808

10" x 7" Classic Series Tom Case
MODEL: GP-PC1007

10" x 8" Classic Series Tom Case
MODEL: GP-PC1008

10" x 10" Classic Series Tom Case
MODEL: GP-PC1010

12" x 8" Classic Series Tom Case
MODEL: GP-PC1208

12" x 9" Classic Series Tom Case
MODEL: GP-PC1209

12" x 10" Classic Series Tom Case
MODEL: GP-PC1010

13" x 9" Classic Series Tom Case
MODEL: GP-PC1309

13" x 10" Classic Series Tom Case
MODEL: GP-PC1310

13" x 11" Classic Series Tom Case
MODEL: GP-PC1311

14" x 12" Classic Series Tom Case
MODEL: GP-PC1412

14" x 14" Classic Series Tom Case
MODEL: GP-PC1414

16" x 14" Classic Series Tom Case
MODEL: GP-PC1614

16" x 16" Classic Series Tom Case
MODEL: GP-PC1616

18" x 14" Classic Series Tom Case
MODEL: GP-PC1814

18" x 16" Classic Series Tom Case
MODEL: GP-PC1816



CLASSIC SERIES BASS DRUM CASES

18" x 14" Classic Series Bass Drum Case
MODEL: GP-PC1814BD

18" x 16" Classic Series Bass Drum Case
MODEL: GP-PC1816BD

20" x 14" Classic Series Bass Drum Case
MODEL: GP-PC2014BD

20" x 16" Classic Series Bass Drum Case
MODEL: GP-PC2016BD

20" x 18" Classic Series Bass Drum Case
MODEL: GP-PC2018BD

22" x 14" Classic Series Bass Drum Case
MODEL: GP-PC2214BD

22" x 16" Classic Series Bass Drum Case
MODEL: GP-PC2216BD

22" x 18" Classic Series Bass Drum Case
MODEL: GP-PC2218BD

22" x 20" Classic Series Bass Drum Case
MODEL: GP-PC2220BD

24" x 14" Classic Series Bass Drum Case
MODEL: GP-PC2414BD

24" x 16" Classic Series Bass Drum Case
MODEL: GP-PC2416BD

24" x 18" Classic Series Bass Drum Case
MODEL: GP-PC2418BD

24" x 16" Classic Series Bass Drum Case
MODEL: GP-PC2416BD

24" x 20" Classic Series Bass Drum Case
MODEL: GP-PC2420BD

CLASSIC SERIES SNARE DRUM CASES

14" x 5" Snare Drum Case; Classic Series
MODEL: GP-PC1405SD

14" x 5" Snare Case w/ Foam
MODEL: GP-PC1405SDF

14" x 5.5" Snare Drum Case; Classic Series
MODEL: GP-PC1405.5SD

14" x 5.5" Snare Case w/ Foam
MODEL: GP-PC1405.5SDF

14" x 6" Snare Drum Case; Classic Series
MODEL: GP-PC1406SD

14" x 6" Snare Case w/ Foam
MODEL: GP-PC1406SDF

14" x 6.5" Snare Drum Case; Classic Series
MODEL: GP-PC1406.5SD

14" x 6.5" Snare Case w/ Foam
MODEL: GP-PC1406.5SDF

PROTECTOR ELITE SERIES

ELITE DRUM CASES



- The Elite Air Series design features an oversized case with tailor-made contours and shaped foam strips to securely cushion each drum
- Drum rest in the middle, away from the side walls, providing a snug fit and eliminating the need for foam
- Accommodates most suspended mounting brackets without upsizing
- Comes with a limited lifetime warranty against cracking
- Adjustable straps with quick-snap clips for easy attachment

Fusion Set Cases; 22" Bass; Elite Air Series
MODEL: GP-PEFUSION22

Sizes In Set:	
10" x 9"	22" x 18"
12" x 10"	14" x 5.5"
14" x 12"	



ELITE SERIES SNARE DRUM CASES

14 x 5" Snare Drum Case; Elite Air Series
MODEL: GP-PE1405SD

14 x 5.5" Snare Drum Case; Elite Air Series
MODEL: GP-PE1405.5SD

14 x 6" Snare Drum Case; Elite Air Series
MODEL: GP-PE1406SD

14 x 6.5" Snare Drum Case; Elite Air Series
MODEL: GP-PE1406.5SD

14 x 8" Snare Drum Case; Elite Air Series
MODEL: GP-PE1408SD

ELITE SERIES TOM DRUM CASES

8" x 8" Elite Air Series Tom Case
MODEL: GP-PE080

10" x 7" Elite Air Series Tom Case
MODEL: GP-PE1007

10" x 8" Elite Air Series Tom Case
MODEL: GP-PE1008

10" x 9" Elite Air Series Tom Case
MODEL: GP-PE1009

12" x 8" Elite Air Series Tom Case
MODEL: GP-PE1208

12" x 9" Elite Air Series Tom Case
MODEL: GP-PE1209

12" x 10" Elite Air Series Tom Case
MODEL: GP-PE1210

13" x 9" Elite Air Series Tom Case
MODEL: GP-PE1309



13" x 10" Elite Air Series Tom Case
MODEL: GP-PE1310

13" x 11" Elite Air Series Tom Case
MODEL: GP-PE1311

14" x 12" Elite Air Series Tom Case
MODEL: GP-PE1412

14" x 14" Elite Air Series Tom Case
MODEL: GP-PE1414

16" x 14" Elite Air Series Tom Case
MODEL: GP-PE1614

16" x 16" Elite Air Series Tom Case
MODEL: GP-PE1616

18" x 16" Elite Air Series Tom Case
MODEL: GP-PE1816



ELITE SERIES BASS DRUM CASES

18" x 16" Elite Air Series Bass Drum Case
MODEL: GP-PE1816BD

20" x 14" Elite Air Series Bass Drum Case
MODEL: GP-PE2014BD

20" x 16" Elite Air Series Bass Drum Case
MODEL: GP-PE2016BD

20" x 18" Elite Air Series Bass Drum Case
MODEL: GP-PE2018BD

22" x 14" Elite Air Series Bass Drum Case
MODEL: GP-PE2214BD

22" x 16" Elite Air Series Bass Drum Case
MODEL: GP-PE2216BD

22" x 18" Elite Air Series Bass Drum Case
MODEL: GP-PE2218BD

22" x 20" Elite Air Series Bass Drum Case
MODEL: GP-PE2220BD

24" x 14" Elite Air Series Bass Drum Case
MODEL: GP-PE2414BD

24" x 18" Elite Air Series Bass Drum Case
MODEL: GP-PE2418BD

24" x 20" Elite Air Series Bass Drum Case
MODEL: GP-PE2420BD

ICON SERIES
HEAVY DUTY PERCUSSION BAGS

NEW!



CYMBAL

Cymbal Bag 22"
SKU: GP-ICON-CYM22

Cymbal Bag 24"
SKU: GP-ICON-CYM24

SNARE

10" x 5" GP-ICON-1005SD	12" x 7" GP-ICON-1207ST	13" x 5" GP-ICON-1305SD	14" x 5" GP-ICON-1405SD	14" x 6.5" GP-ICON-1465SD GP-ICON-1465SD-RED
12" x 5" GP-ICON-1205SD	13" x 3" GP-ICON-1303SD	13" x 7" GP-ICON-1307ST	14" x 5.5" GP-ICON-1455SD GP-ICON-1455SD-RED	14" x 8" GP-ICON-1408SD



TOM

8" x 7" GP-ICON-0807	12" x 9" GP-ICON-1209	15" x 12" GP-ICON-1512
8" x 8" GP-ICON-0808	12" x 10" GP-ICON-1210	15" x 15" GP-ICON-1515
10" x 7" GP-ICON-1007	13" x 9" GP-ICON-1309	16" x 14" GP-ICON-1614
10" x 8" GP-ICON-1008	13" x 10" GP-ICON-1310	16" x 16" GP-ICON-1616
10" x 9" GP-ICON-1009	14" x 10" GP-ICON-1410	18" x 16" GP-ICON-1816
10" x 10" GP-ICON-1010	14" x 12" GP-ICON-1412	
12" x 8" GP-ICON-1208	14" x 14" GP-ICON-1414	

BASS

18" x 14" GP-ICON-1814BD	20" x 16" GP-ICON-2016BD	22" x 16" GP-ICON-2216BD	24" x 16" GP-ICON-2416BD
28" x 16" GP-ICON-1816BD	20" x 18" GP-ICON-2018BD	22" x 18" GP-ICON-2218BD	24" x 18" GP-ICON-2418BD
20" x 14" GP-ICON-2014BD	22" x 14" GP-ICON-2214BD	24" x 14" GP-ICON-2414BD	

SETS

Bop Drum Set Bags
MODEL: GP-ICON-BOP

Sizes In Set:

18" x 14"
12" x 8"
14" x 14"

Jazz Fusion Drum Set Bags
MODEL: GP-ICON-JZFUSION

Sizes In Set:

20" x 16"	14" x 14"
10" x 7"	
12" x 8"	

Rock Drum Set Bags
MODEL: GP-ICON-ROCK

Sizes In Set:

22" x 18"	16" x 16"
10" x 8"	
12" x 9"	



PEDAL BAG

NEW!
Bass Drum Pedal Bag
MODEL: GP-ICON-PEDALBAG

STICK BAG

NEW!
Drum Stick Bag
MODEL: GP-ICON-STICKBAG

PROTECTOR STANDARD SERIES PADDED DRUM BAGS



- Durable 600-denier nylon construction
- 10mm padded and lined interior
- Comfortable carrying straps
- Collapsible compact design

FEATURED MODEL
GP-FUSION16

SNARE	13" x 5.5" GP-1305.5SD	14" x 6.5" GP-1406.5SD
	14" x 5.5" GP-1405.5SD	

TOM	8" x 7" GP-0807	12" x 8" GP-1208	14" x 12" GP-1412
	8" x 8" GP-0808	12" x 9" GP-1209	14" x 14" GP-1414
	10" x 7" GP-1007	12" x 10" GP-1210	16" x 14" GP-1614
	10" x 8" GP-1008	13" x 9" GP-1309	16" x 16" GP-1616
	10" x 9" GP-1009	13" x 11" GP-1311	18" x 16" GP-1816

BASS	18" x 14" GP-1814BD	22" x 16" GP-2216BD	24" x 18" GP-2418BD
	20" x 16" GP-2016BD	22" x 18" GP-2218BD	
	20" x 18" GP-2018BD	24" x 14" GP-2414BD	

NEW!
5-Piece Rock Set Bags
MODEL: GP-ROCK-100

	Sizes In Set	
	6.5" x 14"	10" x 8"
	16" x 16"	22" x 18"
	12" x 9"	

NEW!
5-Piece Jazz Fusion Set
MODEL: GP-JAZZFS-100

	Sizes In Set	
	20" x 16"	14" x 14"
	10" x 7"	5.5" x 14"
	12" x 8"	

5-Piece Fusion Set Bags;
16" Tom
MODEL: GP-FUSION16

	Sizes In Set:	
	10" x 9"	20" x 16"
	12" x 10"	14" x 5.5"
	14" x 12"	

NEW!
4-Piece Bop Set Bags
MODEL: GP-BOP-100

	Sizes In Set	
	18" x 14"	5.5" x 14"
	12" x 8"	
	14" x 14"	

5-Piece Fusion Set Bags
MODEL: GP-FUSION-100

	Sizes In Set:	
	10" x 9"	22" x 18"
	12" x 10"	14" x 5.5"
	14" x 12"	

5-Piece Standard Set
MODEL: GP-STANDARD-100

	Sizes In Set:	
	12" x 10"	22" x 18"
	13" x 11"	14" x 6.5"
	16" x 16"	

PROTECTOR CLASSIC CYMBAL SERIES CYMBAL CASE; CLASSIC SERIES MOLDED PE

- Features a strapless design and wing nut system to securely hold cymbals (up to 22") in place
- Accommodates cymbals up to 22"
- Molded carry handle
- Comes with a limited, lifetime warranty against cracking

Cymbal Case; Classic Series
MODEL: GP-PC302



WING NUT SYSTEM

PROTECTOR ELITE CYMBAL SERIES CYMBAL CASE; ELITE AIR SERIES MOLDED PE; WITH HANDLE & WHEELS

- Features a strapless design and wing nut system to securely hold cymbals in place
- Accommodates cymbals up to 22"
- Molded handles offer durable and comfortable carrying option
- Recessed wheels and an extended handle that folds away when not in use
- Comes with a limited lifetime warranty against cracking
- Available in custom colors

Cymbal Case; Elite Air Series
MODEL: GP-PE302



WING NUT SYSTEM

PROTECTOR LIGHTWEIGHT CYMBAL SERIES

CYMBAL SLINGER BAG

- Durable nylon exterior with protective foam
- Protective padded interior lining
- Fits up to eight cymbals up to 22" diameter
- Individual dividers
- Comfortable shoulder strap

Cymbal Bag; Slinger-Style
MODEL: GP-12



PROTECTOR LIGHTWEIGHT CYMBAL SERIES

CYMBAL BAG WITH BACKPACK STRAPS

- Fits cymbals up to 22" or 24"
- Ultra padded adjustable backpack straps
- Large front pocket to hold your loaded stickbag
- 3 additional storage pockets
- Removable padded shoulder strap
- Heavily padded back section
- Neoprene wrap padded handle
- Plastic lined divided interior
- Durable 600d nylon with 1200d
- Reinforced bottom

22" Cymbal Backpack
MODEL: GP-CYBAK-22

24" Cymbal Backpack
MODEL: GP-CYBAK-24

FEATURED MODEL
GP-CYBACK-22



ADDED ADJUSTABLE BACKPACK

PROTECTOR ELECTRONIC SERIES

LARGE ELECTRONIC DRUM KIT BAG WITH WHEELS

- Stores electric drum pads, cymbal pads, electric drum set brain, module, and accessories
- Wheels and tow handle
- 25mm padded tricote interior
- 2 Nylon web carry handles
- Padded removable adjustable shoulder strap

Large Electronic Drum Kit Bag w/ Wheels
MODEL: GP-EKIT3616-BW



PROTECTOR CLASSIC ACCESSORY SERIES

HARDWARE TRAP CASE WITH REMOVABLE TRAY AND HEAVY-DUTY RECESSED WHEELS



MADE IN THE USA

- Deluxe rotationally molded case for drum hardware and accessories
- Carpet lined interior prevents hardware from scratches during transport
- Removable top tray is carpet lined and perfect for additional hardware or accessories such as drum throne, stick bag, or axillary percussion
- Heavy-duty web straps with quick release buckles secure the lid
- Recessed blue rubber wheels
- 6 Spring-loaded, rubber gripped handles provide various carry and tow options
- Molded lid allows for stacking with additional Gator trap cases or the Evolution snare cases

Deluxe Hardware Trap Case - 36"x14"x16"
MODEL: GP-TRAP-3614-16



RECESSED WHEELS



SPRING-LOADED RUBBER GRIP HANDLES



REMOVABLE, CARPET LINED TOP TRAY

DRUM ACCESSORY CASES

MADE IN THE USA



FEATURED MODEL
GP-PC300

FEATURED MODEL
GP-PC304W-4

FEATURED MODEL
GP-PC308W

Accessory Case; Super Compact - 45"x19"x12"
MODEL: GP-PC300

Accessory Case; Super Compact - 30"x14"x12" w/ Wheels
MODEL: GP-PC308W

Accessory Case; Compact - 36"x16"x12"
MODEL: GP-PC304

Accessory Case; Upright - 36"x16"x12" w/ wheels
MODEL: GP-PC304WU

Caster Kit; 2" Stationary
MODEL: GP-4300-CT

Caster; 2" Swivel w/ Threaded Stem
MODEL: GP-4305-CT

PROTECTOR HARDWARE SERIES

DRUM HARDWARE BAG WITH STEEL FRAME & 100 POUND CAPACITY IN-LINE WHEELS

- 600-Denier nylon drum hardware bag
- Bag section is removable from the rolling cart
- 25mm Steel rolling cart
- Large 100-pound capacity in-line style wheels
- Several exterior accessory pockets for accessories
- Two (2) sets of secure wrap carry handles on the bag
- Extra-long bag allows you to leave hardware adjustments set
- Heavy-duty #10 zippers



REMOVABLE ROLLING CART



AMPLE STORAGE CAPABILITIES

Hardware Cart; Steel Frame
MODEL: GP-DRUMCART

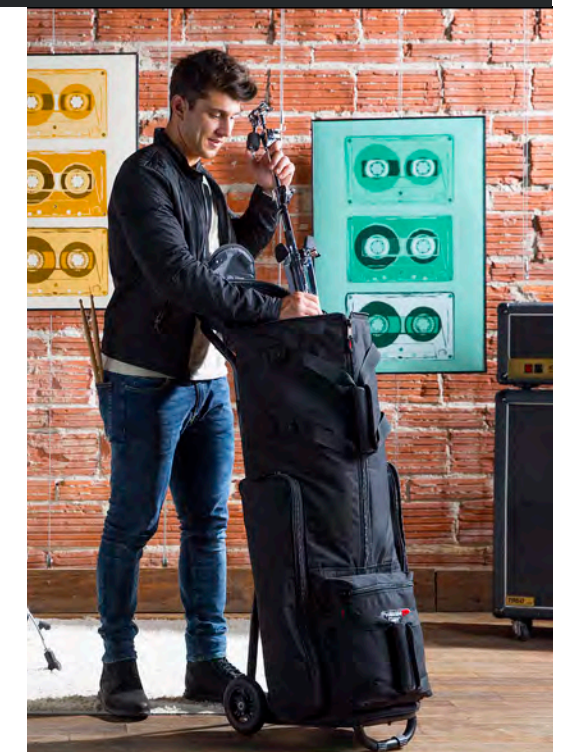

PROTECTOR HARDWARE SERIES DRUM HARDWARE BAGS

- Durable 600-denier nylon construction
- #10 Zippers
- Reinforced carry handles
- Synthetic fur-lined interior

PE VERSION FEATURES

- Reinforced carry handles
- Rigid polyethylene base
- Recessed roller wheels
- Padded interior Velcro tie down straps



FEATURED MODEL
GP-HDWE-1350

FEATURED MODEL
GP-HDWE-1436-PE

Drum Hardware Bag; 13" x 50"
MODEL: GP-HDWE-1350

Drum Hardware Bag; 14" x 36"
MODEL: GP-HDWE-1436

**Drum Hardware Bag; 14" x 36";
w/ Wheels**
MODEL: GP-HDWE-1436W

**Hardware Bag; 14" x 36"
w/ Wheels; Molded Bottom**
MODEL: GP-HDWE-1436-PE

**Hardware Bag; 18" x 46" w/
Wheels; Molded Bottom**
MODEL: GP-HDWE-1846-PE

PROTECTOR HARDWARE SERIES ACCESSORY BAGS



- Durable Nylon Exterior
- 20mm Foam Protection
- Synthetic Fur Lining
- Comfortable web handles
- Shoulder strap

Hardware Bag; 19" x 12.5" x 12.5"
MODEL: GP-40



- Synthetic fur lining
- 30mm Spongy foam lining
- Exterior accessory pocket
- Carry handles and removable shoulder strap

Hardware / Double Bass Pedal Bag
MODEL: GP-66

DELUXE DRUMSTICK BAG LEATHERETTE STICK BAG WITH REMOVABLE SLEEVE

- Removable, Live-In Stick Sleeve Included
- Drum-Mounting Hooks on Both Bag & Sleeve
- Six (6) Interior Compartments for Various-Size Drumsticks & Mallets with a Dedicated Mini Drum Key Window Pocket
- Two (2) Outside Zipper Pockets for Storing Sheet Music, Accessories, & Personal Items
- Dual Carry Handles & Padded, Ambidextrous Shoulder Strap
- Heavy-Duty, Self-Healing Nylon Coil Zippers

**Deluxe Drumstick Bag with
Removable Stick Sleeve**
MODEL: GP-STICKBAG-DLX



ACCESSORY POCKETS



REMOVABLE STICK SLEEVE



• Drum-Mounting
Hooks on Both Bag
& Sleeve



• Drum-Mounting
Hooks on Both Bag
& Sleeve

PROTECTOR LIGHTWEIGHT STICK SERIES

NYLON, FUR-LINED STICK & PERCUSSION Mallet BAG

- Holds drum sticks and percussion mallets
- 25mm Foam padding
- Synthetic fur lining
- Straps for attaching to floor tom

Protector Series Stick and Mallet Bag
MODEL: GP-007A



FUR LINING



STANDARD DRUMSTICK & Mallet BAG

NEW!

- Durable Fabric to Handle Daily Travel and Usage
- Eight (8) Pockets Safely Store Sticks, Mallets and Various Percussion Implements
- Hanging Loops to Easily Attach and Remove from Mallet Keyboards
- Retractable Pull String to Effortlessly Hang from a Floor Tom
- Large Exterior Pockets to Storage Sheet Music, Method Books, and Various Accessories
- Comfortable Shoulder Strap for Easy and Comfortable Travel

Standard Drumstick & Mallet Bag
MODEL: GP-STICKBAG-STD

Eight (8) Pockets Safely Store Sticks, Mallets and Various Percussion Implements



ROUND-TOP DRUM THRONE

WITH SPINDLE ADJUSTMENT



- Spindle-Locking Mechanism for Quick & Easy Height Adjustment: 18.5-24" (470-610mm)
- Foam-Padded Seat Cushion for Extra Comfort During Long Rehearsals & Performances: 11.75 x 2.5" (298 x 64mm)
- Tough, Double-Braced Legs with Minimal Noise During Use
- Collapsible Tripod Base with Non-Slip Rubber Feet

Round Top Drum Throne
MODEL: GFW-DRUMTHRONE-R



FOAM-PADDED SEAT



NON-SLIP RUBBER FEET



COLLAPSIBLE TRIPOD BASE

AIR GLIDE SERIES DRUM THRONES

AVAILABLE IN BLACK, BLUE, AND RED

NEW!



****Compatible with Gator Drum Throne Backrests**

- **PREMIUM COMFORT & COMPATIBILITY:** Breathable red velour top reduces sweating and enhances stability; Compatible with Gator's optional supportive backrest for added ergonomic support and performance longevity.
- **EASY AIR GLIDE ADJUSTMENT:** Pneumatic height control allows smooth, effortless adjustments from 18" - 24" (45.7 - 61.0 cm), giving drummers perfect positioning and comfort during every performance. The maximum weight recommendation is 330 lb (150 kg).
- **ERGONOMIC SADDLE SEAT DESIGN:** Thick 3.5" (8.9 cm) padded contoured seat measures 17.25" wide x 16" deep (43.8 x 40.6 cm) with leg relief cutouts, delivering superior comfort and support for long gigs or studio sessions.
- **HEAVY-DUTY STABILITY:** Deluxe chrome-plated, double-braced steel tripod base provides maximum durability, while oversized rubber feet and a wide 23" (58.4 cm) stance ensure superior grip and balance.

Air Glide Saddle Seat Drum Throne - Blue
MODEL: GP-DTH-ASD-BL

Air Glide Saddle Seat Drum Throne - Black
MODEL: GP-DTH-ASD-BK

Air Glide Saddle Seat Drum Throne - Red
MODEL: GP-DTH-ASD-RD



SPINDLE SADDLE SEAT DRUM THRONE

IN BLACK WITH ERGONOMIC SEAT

NEW!

- **PREMIUM COMFORT & COMPATIBILITY:** Designed with premium comfort in mind, with a breathable black velour top that reduces sweating and enhances stability.
- **SOLID SPINDLE ADJUSTMENT:** Solid spindle with Spin Lock Height Adjustment from 19.25" - 26.5" (48.9 - 67.3 cm) allows quick, secure, and wobble-free positioning while maintaining your preferred height with built-in memory lock functionality. The maximum weight recommendation is 330 lb (150 kg).
- **PADDED SEAT DESIGN:** Thick padded contoured seat delivering superior comfort and support for long gigs or studio sessions.
- **HEAVY-DUTY STABILITY:** Chrome-plated, double-braced steel tripod base ensures maximum durability, while oversized rubber feet and a wide stance provide superior grip, balance, and longevity under demanding playing conditions.

****Saddle Seat Compatible with Gator Drum Throne Backrests**

Spindle Saddle Seat Drum Throne
MODEL: GP-DTH-SSD-BK

Spindle Round Seat Drum Throne
MODEL: GP-DTH-SRD-BK



DRUM THRONE BACKRESTS

COMPATIBLE WITH GATOR AIR GLIDE SERIES & SPINDLE SADDLE SEAT THRONES

NEW!

- **ERGONOMIC BACK SUPPORT:** Designed for Gator Air Glide and Spin Lock Spindle drum thrones, this height-adjustable backrest adds superior lumbar support, helping reduce fatigue and improve posture during long performances or studio sessions.
- **PERSONALIZED HEIGHT ADJUSTMENT:** Features up to 4" (10.2 cm) of vertical adjustment, allowing drummers to easily set their preferred position. Provides 1.75" - 5.75" (4.4 - 14.6 cm) seat clearance for a tailored ergonomic fit.
- **PREMIUM COMFORT DESIGN:** 2" (5.1 cm) thick padding offers excellent cushioning and support. The backrest measures 7.5" high x 15" wide x 2" deep (19 x 38 x 5 cm), delivering consistent comfort and coverage during extended play.
- **BREATHABLE AND DURABLE:** Velour surface enhances airflow to reduce sweating and maintain comfort, while its sturdy construction ensures lasting durability; Perfect for drummers who demand both performance and reliability.



Drum Throne Backrest - Blue
MODEL: GP-DTH-BR-BL

Drum Throne Backrest - Black
MODEL: GP-DTH-BR-BK

Drum Throne Backrest - Red
MODEL: GP-DTH-BR-RD

GATOR STAGE & DRUM RUG

6.5' X 5.5' SLEEK, PROFESSIONAL-GRADE DRUM RUG

NEW!



- Stylish and modern drum rug with Gator logo, ideal for professional settings, studio use, or live gigs where a splash of style is preferred.
- Non-slip rubber underside grips hard floors and carpeted surfaces, keeping your drum kit, hardware, and stands securely in place.
- Constructed from plush fabric that's safe for all drum finishes and protects underlying surfaces from scuffs, debris, and marring.
- Exterior dimensions measure 78" x 66" x .25" (198.1cm x 167.6cm x .64cm (L x W x H)) with a net weight of 9.6 lb (4.36kg), offering generous space for small to large drum kit configurations.

Gator 78" x 66" Drum Rug - Black

MODEL: GP-DRUMRUG-BK

Gator 78" x 66" Drum Rug - Abstract

MODEL: GP-DRUMRUG-BKRW



SNARE DRUM RACK

HOLDS UP TO 10 SNARE DRUMS

- Holds up to 10 Snare Drums of any Size
- 36" Crossbars Provide Space for 5 Snare Drums on each Tier
- Locking Casters for Ultimate Stability and Versatility
- 40mm Foam Padding on Crossbars Prevents Metal-to-Metal Contact
- Additional Padded Protection Across Upper Tier Side Bars
- Easy to Assemble and Disassemble with Dependable Hex Key Bolts
- Rugged Frameworks Steel Construction

Two-Tier Snare Rack with Locking Casters

MODEL: GFW-SDRACK-T2



RED LOCKING CASTERS



FREQUENT FLYER SERIES

TSA-ACCEPTED MOLDED CASE FOR YAMAHA EAD10

NEW!

- PERFECT FIT FOR YAMAHA EAD10: Custom-designed TSA case engineered to hold the Yamaha EAD10 module and included mic pickup system securely, with dedicated compartments for accessories, cables, and more. Internal module compartment dimensions 10.3" x 5.3" (L x W) (26.2 x 13.5 cm (L x W)).
- PROTECTIVE INTERIOR: Foam-cushioned, tricot-lined interior with convolute foam in the lid keeps gear snug and protected from scratches, dents, and shifting during travel. Internal accessory compartments dimensions include 10.3" x 3.0" x 4" (L x W x H) (26.2 x 7.6 x 10.2 cm (L x W x H)) / 5.0" x 3.5" x 4.0" (L x W x H) (12.7 x 8.9 x 10.2 cm (L x W x H))
- RUGGED DURABILITY: Built with a tough ABS and EVA polyethylene hardshell exterior and molded design for impact resistance and long-lasting protection on the road. External dimensions 17.75" x 13.50" x 6.75" (L x W x H) (45.1 x 34.3 x 28.7 cm (L x W x H)).
- TRAVEL-READY SECURITY: TSA-accepted locking latch with included key and quick-release draw latches ensures fast access, while providing maximum security and peace of mind during air travel.



TSA-Accepted Molded Case for Yamaha EAD10

MODEL: GTS-YAMEAD10

WORLD PERCUSSION CASES

MOLDED PE CASES

- Recognized as the industry standard rotationally molded drum cases
- Provides strength, durability, and simplicity for almost any drum size
- The rotational molding process gives added strength and durability to case corners and provides water resistance that non-roto molded cases can't match
- Comes with a limited, lifetime warranty against cracking



FEATURED MODEL
GP-PC2617PD



FEATURED MODEL
GP-PC310

Pan Case w/ Foam, 22" x 11"
MODEL: GP-PC2211DP

Pan Case w/ Foam & Wheels, 22" x 11"
MODEL: GP-PC2211DPW

26" Steel Drum Case
MODEL: GP-PC2617PD

Upright Timbale Case w/ Wheels
MODEL: GP-PC310



WORLD PERCUSSION BAGS

PADDED BAGS



Padded Conga Bag with Adjustable Strap; with Wheels

- Reinforced carry handles
- Rigid polyethylene base
- Recessed roller wheels
- Padded interior Velcro tie down straps

Padded Conga Bag
MODEL: GP-CONGA-W

Padded Bongo Bag

- Synthetic fur lining
- 30mm Spongy foam lining
- Exterior accessory pocket
- Carry handles & removable shoulder strap down straps

Padded Bongo Bag
MODEL: GP-66



PROTECTOR CLASSIC MARCHING SERIES

MARCHING PERCUSSION CASES



FEATURED MODEL
GP-PC217

FEATURED MODEL
GP-PC2614MBD

FEATURED MODEL
GP-PC2814MBD

- Recognized as the industry standard rotationally molded drum cases
- Provides strength, durability, and simplicity for almost any drum size
- The rotational molding process gives added strength and durability to case corners and provides water resistance that non-roto molded cases can't match
- Comes with a limited, lifetime warranty against cracking



Marching Snare Case - Classic Series
MODEL: GP-PC217

26" x 14" Classic Series Marching Bass Drum Case
MODEL: GP-PC2614MBD

28" x 14" Classic Series Marching Bass Drum Case
MODEL: GP-PC2814MBD

ELITE AIR SERIES - MARCHING SNARE CASE

MARCHING SNARE CASE WITH WHEELS

- The Elite Air Series design features an oversized case with tailor-made contours and shaped foam strips to securely cushion each drum
- Drum rest in the middle, away from the side walls, providing a snug fit and eliminating the need for foam
- Accommodates most suspended mounting brackets without upsizing

- Comes with a limited lifetime warranty against cracking
- Adjustable straps with quick-snap clips for easy attachment
- Includes wheels for easy transport

Marching Snare Drum Case with Wheels
MODEL: GP-PE217W

CLAW SERIES - MALLET HOLDER

BASS DRUM MALLET HOLDER FOR 14" & 16" DEEP MARCHING BASS DRUMS

- Revolutionary spring-loaded, quick-release system provides quick bass drum mallet placement for 14" and 16" deep marching bass drums
- Attractive and strong black anodized finish
- Strong aluminum edge for optimal protection against rim clicks

Bass Drum Mallet Holder
MODEL: GP-XLA-CLAW



CABLES

Whether you're playing live, recording, rehearsing with the band, or just practicing at home, a bad cable can distract you from your best performance. Cableworks understands that the best cables are the ones you never have to think about.



BACKLINE SERIES.....	188
COMPOSER SERIES.....	190
HEADLINER SERIES.....	192

BACKLINE SERIES CABLES

SPEAKER, INSTRUMENT & XLR CABLES



FEATURED MODEL
GCWB-DS6X2-20

NEW!
BACKLINE
DROP SNAKES



NEW!
6-Channel Drop Snake
XLR Box Input - XLR Fan

MODEL NO.	CABLE LENGTH
GCWB-DS6X2-20	20 Foot
GCWB-DS6X2-30	30 Foot
GCWB-DS6X2-50	50 Foot



NEW!
8-Channel Drop Snake
XLR Box Input - XLR Fan

MODEL NO.	CABLE LENGTH
GCWB-DS8X2-25	25 Foot
GCWB-DS8X2-50	50 Foot



NEW!
Balanced
1/4" TRS Male - 1/4" TRS Male

MODEL NO.	CABLE LENGTH
GCWB-BPC-1	1 Foot
GCWB-BPC-2	2 Foot
GCWB-BPC-3	3 Foot
GCWB-BPC-5	5 Foot
GCWB-BPC-10	10 Foot
GCWB-BPC-15	15 Foot
GCWB-BPC-20	20 Foot
GCWB-BPC-30	30 Foot
GCWB-BPC-50	50 Foot

- Cableworks Backline Series cables are a best-in-class line of cables for music and audio professionals.
- The line consists of Instrument, XLR, Speaker, and Patch cables to accommodate all your audio needs.
- With highly durable and flexible jackets, classic reliable connectors, and oxygen-free conductors, the Backline series can be relied upon every time you plug it in.



XLR

GCWB-XLR-03	3 Foot
GCWB-XLR-05	5 Foot
GCWB-XLR-10	10 Foot
NEW! GCWB-XLR-15	15 Foot
GCWB-XLR-20	20 Foot
NEW! GCWB-XLR-25	25 Foot
GCWB-XLR-30	30 Foot
GCWB-XLR-50	50 Foot



NEW!
Braided Straight to Right Angle

GCWB-INS-10RA	10 Foot
GCWB-INS-20RA	20 Foot



Straight to Straight Instrument

GCWB-INS-05	5 Foot
GCWB-INS-10	10 Foot
GCWB-INS-20	20 Foot
GCWB-INS-30	30 Foot



Straight to Right Angle Instrument

GCWB-INS-05RA	5 Foot
GCWB-INS-10RA	10 Foot
GCWB-INS-20RA	20 Foot
GCWB-INS-30RA	30 Foot



Right Angle to Right Angle Instrument Patch

GCWB-INS-6INRA3PK	6 Inch
-------------------	--------



TS to Twist Lock Speaker

GCWB-SPK-10-ITL	10 Foot
GCWB-SPK-25-ITL	25 Foot
GCWB-SPK-50-ITL	50 Foot



Twist Lock to Twist Lock Speaker

GCWB-SPK-10-2TL	10 Foot
GCWB-SPK-25-2TL	25 Foot
GCWB-SPK-50-2TL	50 Foot



TS Speaker

GCWB-SPK-03	3 Foot
GCWB-SPK-06	6 Foot
GCWB-SPK-10	10 Foot
GCWB-SPK-25	25 Foot
GCWB-SPK-50	50 Foot

COMPOSER SERIES CABLES

SPEAKER, INSTRUMENT & XLR CABLES

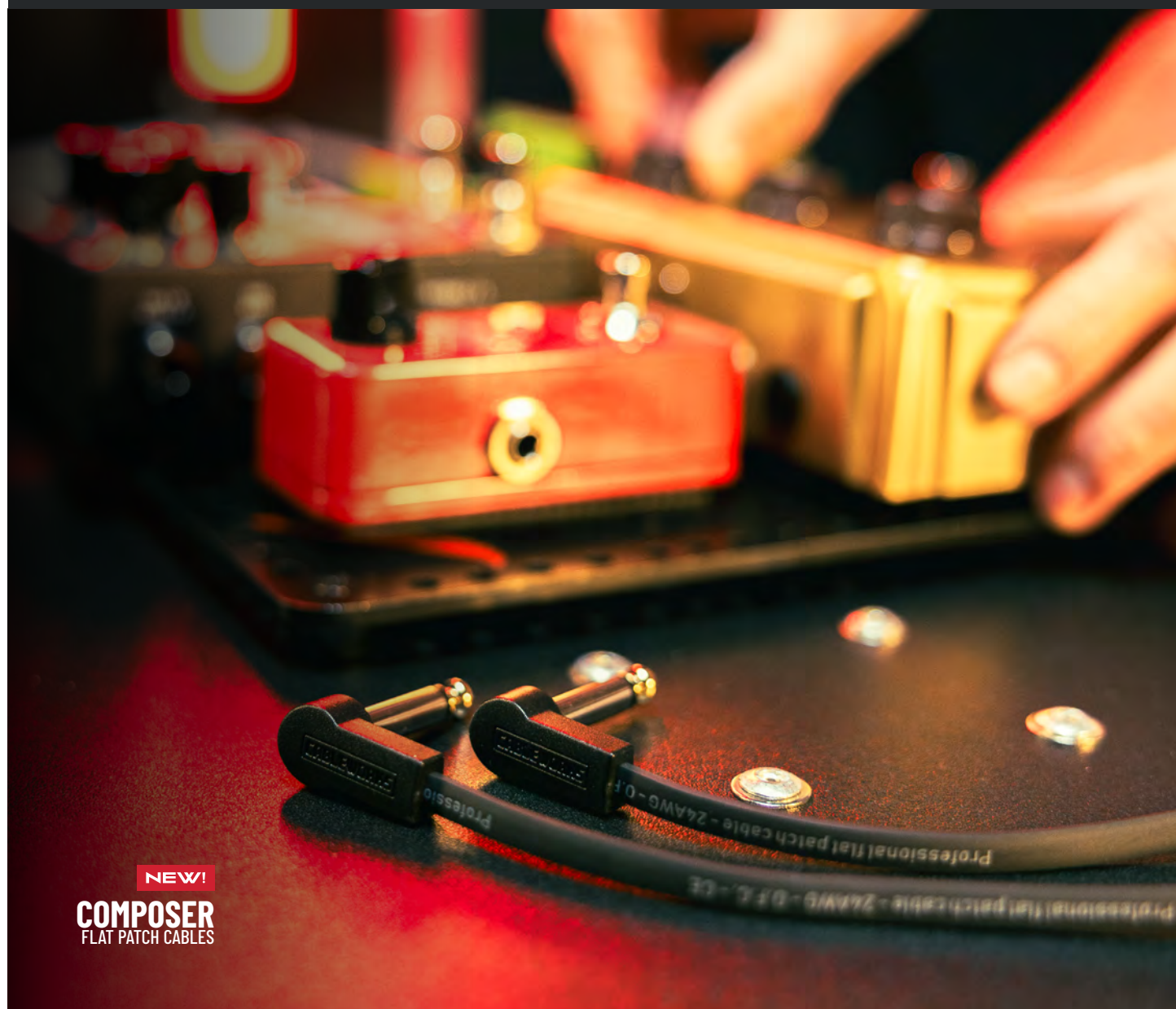

NEW!
COMPOSER
FLAT PATCH CABLES



NEW!
Flat Patch Cables
1/4" Right Angle TS

MODEL NO.	CABLE LENGTH
GCWC-FPC3*	3 Foot
GCWC-FPC6*	6 Foot
GCWC-FPC12*	12 Foot
GCWC-FPC24	24 Foot

*Available in 3-Pack



NEW!
Wireless Bodypack Instrument

GCWC-TA4F-3	3 Foot
GCWC-TA4F-3RA	20 Foot

- The Composer Series is Cableworks professional cable offering, featuring upgraded and well-shielded, low-capacitance conductors, durable PVC jackets for flexibility and reliability, and Cableworks "Patent Pending" connectors.
- These connectors feature our TORIColor ID rings which allow for easy identification when using multiple cables. The Composer Series includes a full assortment of Instrument, XLR, and Speaker cables to support all your professional audio needs.



XLR Female to TRS

GCWC-XLR-18INFTRS	18 Inch
GCWC-XLR-05FTRS	5 Foot
GCWC-XLR-10FTRS	10 Foot
GCWC-XLR-20FTRS	20 Foot

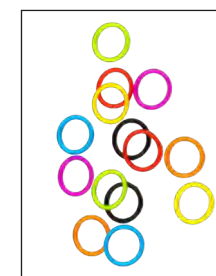

TORI COLOR RINGS



XLR Male to TRS

GCWC-XLR-181MTRS	18 Inch
GCWC-XLR-05MTRS	5 Foot
GCWC-XLR-10MTRS	10 Foot
GCWC-XLR-20MTRS	20 Foot



XLR

GCWC-XLR-03	3 Foot
GCWC-XLR-06	6 Foot
GCWC-XLR-10	10 Foot
NEW! GCWC-XLR-15	15 Foot
GCWC-XLR-20	20 Foot
NEW! GCWC-XLR-25	25 Foot
GCWC-XLR-30	30 Foot
GCWC-XLR-50	50 Foot
GCWC-XLR-75	75 Foot
GCWC-XLR-100	100 Foot



Straight to Straight Instrument

GCWC-INS-03	3 Foot
GCWC-INS-10	10 Foot
GCWC-INS-20	20 Foot
GCWC-INS-30	30 Foot



TS to Twist Lock Speaker

GCWC-SPK-03-ITL	3 Foot
GCWC-SPK-06-ITL	6 Foot
GCWC-SPK-10-ITL	10 Foot
GCWC-SPK-15-ITL	15 Foot
GCWC-SPK-25-ITL	25 Foot
GCWC-SPK-50-ITL	50 Foot
GCWC-SPK-100-ITL	100 Foot



Straight to Right Angle Instrument

GCWC-INS-03RA	3 Foot
GCWC-INS-10RA	10 Foot
GCWC-INS-20RA	20 Foot
GCWC-INS-30RA	30 Foot



Twist Lock to Twist Lock Speaker

GCWC-SPK-03-2TL	3 Foot
GCWC-SPK-06-2TL	6 Foot
GCWC-SPK-10-2TL	10 Foot
GCWC-SPK-15-2TL	15 Foot
GCWC-SPK-25-2TL	25 Foot
GCWC-SPK-50-2TL	50 Foot



HEADLINER SERIES CABLES

SPEAKER, INSTRUMENT & XLR CABLES



NEW!
Wireless Bodypack Instrument
 GCWH-TA4F-30T 3 Foot
 GCWH-TA4F-3RA0T 20 Foot

NEW!
HEADLINER
 WIRELESS BODYPACK
 INSTRUMENT CABLES



- The Headliner Series is Cableworks premium cable offering that features our best-performing, lowest capacitance conductors, providing optimal signal transmission.
- Headliner cables come wrapped in sturdy, flexible PVC jackets that result in an extremely durable and reliable cable that will stand the test of time.
- The Headliner Instrument, XLR, and TS Speaker cables include Cableworks "Patent Pending" connectors that feature a rugged design highlighted by our TORICOLOR ID rings for easy identification when using multiple cables.

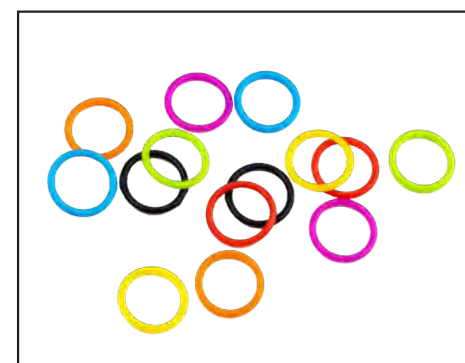

TORI COLOR RINGS



Straight to Right Angle Quiet Instrument

GCWH-INS-10RA0T	10 Foot
GCWH-INS-20RA0T	20 Foot
GCWH-INS-30RA0T	30 Foot



Straight to Right Angle Instrument

GCWH-INS-6INRA	6 Inch
GCWH-INS-03RA	3 Foot
GCWH-INS-10RA	10 Foot
GCWH-INS-20RA	20 Foot
GCWH-INS-30RA	30 Foot



Straight to Straight Instrument

GCWH-INS-03	3 Foot
GCWH-INS-10	10 Foot
GCWH-INS-20	20 Foot
GCWH-INS-30	30 Foot



Straight to Straight Quiet Instrument

GCWH-INS-100T	10 Foot
GCWH-INS-200T	20 Foot
GCWH-INS-300T	30 Foot



TS to Twist Lock Speaker

GCWH-SPK-03-1TL	3 Foot
GCWH-SPK-06-1TL	6 Foot
GCWH-SPK-10-1TL	10 Foot
GCWH-SPK-15-1TL	15 Foot
GCWH-SPK-25-1TL	25 Foot



Twist Lock to Twist Lock Speaker

GCWH-SPK-03-2TL	3 Foot
GCWH-SPK-06-2TL	6 Foot
GCWH-SPK-10-2TL	10 Foot
GCWH-SPK-15-2TL	15 Foot
GCWH-SPK-25-2TL	25 Foot



TS Speaker

CBW-HDLSPKR-CBLE-3	3 Foot
CBW-HDLSPKR-CBLE-6	6 Foot
CBW-HDLSPKR-CBLE-10	10 Foot
CBW-HDLSPKR-CBLE-15	15 Foot
CBW-HDLSPKR-CBLE-25	25 Foot



XLR

CBW-HDLXLR-CBLE-3	3 Foot
CBW-HDLXLR-CBLE-6	6 Foot
CBW-HDLXLR-CBLE-10	10 Foot
CBW-HDLXLR-CBLE-20	20 Foot
CBW-HDLXLR-CBLE-50	50 Foot
CBW-HDLXLR-CBLE-75	75 Foot



Follow us on social:



@gatorcases



GATORCASES

GATORFRAMEWORKS

GATORRACKWORKS

GATORCABLEWORKS



SHURE

Official
Licensed
Product
Licensed by Gator Cases

@2025 Gator Co. All Rights Reserved.
Specifications and products subject to change without notice.